

HIGH-PERFORMANCE VECTOR INVERTER

OPERATING MANUAL

MANUAL



Directory

1.Safety information.....	3
1.1 Safety Precautions.....	3
1.2 Installation and wiring.....	3
1.3 Operation Environment.....	4
2.Technical Index and Specification.....	5
2.1 Technical Index and Specification.....	5
2.2 Chassis and keyboard dimensions.....	7
2.3 Rated current output table.....	8
2.4 Selection of braking resistor.....	9
3.Basic Running Wiring.....	11
3.1 Basic wiring diagram.....	11
3.2 Terminal of control loop.....	12
3.3 Control Loop Terminal Function Table.....	12
3.4 Dial Switch.....	13
3.5 Wiring Notices.....	13
4.Operation and display.....	15
4.1 Operating panel.....	15
4.2 Operation Panel Keys.....	15
4.3 LED and Indicator Light Description:	16
5.Function Code.....	17
6.Detailed explanation of parameters.....	43
F0 Group - Basic Run Parameters.....	43
F1 Group - Motor Parameters.....	48
F2 Group Speed Loop, Torque and Flux Control Parameter.....	49
F3 Group VF control parameter.....	53
F4 Group - Digital Input Parameters.....	57
F5 Group - Digital Output Parameters.....	65
F6 Group - Auxiliary Operating Parameters.....	69
F7 Group – Panel Function Setting and Parameter Management.....	72
F8 Group - Auxiliary function.....	74
F9 Group Protection Parameter.....	77
FA Group – PID Control Parameters.....	82

Directory

FB Group-Transpose and Fixed Length Control.....	86
FC Group Programmable Operation Parameter.....	90
Fd Group Communication Parameter.....	95
FE Group Advance Function Parameter and Performance Parameter.....	96
7.Troubleshooting.....	101
7.1 Fault information and Troubleshooting.....	101
7.2 Abnormal Phenomena Solution.....	103
Appendix: A. Communication Protocol.....	105
B.Warranty agreement.....	114

1. Safety information

1.1 Safety Precautions

- Do not install this equipment in an explosive gas atmosphere, or there will be explosion hazards.
- Only qualified individuals should proceed with wiring, or there will be electric shock hazards. Do not conduct any wiring during the system power on to avoid the electric shock..
- Do not touch control terminals, internal circuit board and its components, or there will be electric shock hazard.
- Earth terminal must be exactly grounded when using inverter. Grounding must be confirmed with the national electric safety regulation and other electric code.
- After power off, do not touch internal circuit board or any parts inside within 5 minutes after keypad display went off. Any internal operation must be after making sure of discharge off with instrument checking to avoid the electric shock.
- Do not connect AC power to output terminal (U, V, W) of inverter. The only terminal the AC power allowed to be connected is R, S, T (or L1, L2 single-phase source inverter).
- Static electricity on human body can damage MOS device. Do not touch PCB and IGBT without anti-static measure.
- Do not lose screws, spacers and other metallic foreign bodies inside the driver to avoid fire hazard and driver damage.
- Do not connect 220V AC power to internal control terminal of the driver, or there will be serious damage to the driver.
- If overcurrent protection occurs after start the driver, confirm again the external wiring and then power on and run the driver.
- Do not switch off the power to stop the driver. Cut off power source after the motor stops running.
- Do not install the driver in places with direct sunlight.

1.2 Installation and wiring

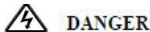

- Ensure the power has been cut off before wiring.
Electric shock and fire hazard.
- Ask electric engineering professionals to conduct wiring.
Electric shock and fire hazard.
- Earth terminals must be reliable grounded.
(380V class: especially the third grounding) Electric shock and fire hazard.
- Check if its action is effective after emergency brake terminal is connected.
Injury risk (wiring responsibility should be beard by users).
- Do not touch output terminals directly. The output terminal is connected directly to motor. There should be no short circuit between output terminals.
Electric shock and short circuit hazard.
- Install the terminal cover before power on, and ensure power off when dismantling the terminal cover.
Electric shock hazard.
- Conduct check and maintenance after 5~8 minutes after power off when internal residual electricity is discharged completely.
Hazard of residual voltage in electrolytic capacitor.

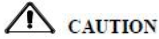
information

- Check if the voltage of power inlet wire agrees with rated input voltage of VFD.
Injury and fire hazard.
- Connect brake resistor or brake unit according to wiring diagram.
Fire hazard.
- Choose screw driver and wrench with specified torque to fasten terminals.
Fire hazard.
- Do not connect the power input wire to output U, V, W terminals.
It will cause internal damage to VFD if load the voltage on output terminals.
- Do not dismantle the front panel cover, only the terminal cover needs to be dismantled when wiring.
It may cause internal damage to VFD.

1.3 Operation Environment

- No corrosive gases, vapors, dust or oily dust, no direct sunlight.
- No floating dust and metal particle.
- Ambient humidity 20%~90% RH.
- Vibration less than 5.9m/s²(0.6g).
- No electromagnetic interference.
- Ambient temperature -10°C~40°C. Ensure good ventilation when ambient temperature exceeds 40°C.
- Use electric cabinet or remote control method in non-standard operation environment and ensure good ventilation and heat dissipation. The service life of VFD lies in installing environment and operation condition. But even in standard environment, a long-term continuous running can guarantee a life of no more than 5 years for electrolytic capacitor and about 3 years for cooling fan. An update or a thorough maintenance in advance is recommended.

2. Technical Index and Specification

2.1 Technical Index and Specification

Input	Rated Voltage,	3-phase (4T#series) 380V;50/60HZ 1-phase (2S#series) 220V;50,60HZ		
	Allowed Voltage	3-phase (4T#series) 320V~460V 1-phase (2S#series) 160V~260V		
Output	Voltage	4T#series; 0~460V 2S#series; 0~260V		
	frequency	Low frequency mode: 0~300HZ ; High frequency mode: 0~3000HZ		
	Overload	G type: 110% for long-term, 150% for 1 min, 180% for 5s P type: 105% for long-term, 120% for 1 min, 150% for 1s		
Control Mode		V/F control, advanced V/F control, V/F separation control, electric current vector		
Control Character	Frequency Setting Resolution	Analog Input	0.1% of maximum output frequency	
		Digital Setting	0.01 Hz	
	Frequency	Analog Input	Within 0.2% of maximum output frequency	
		Digital Setting	Within 0.01% of set output frequency	
	V/F Control	V/F Curve (voltage frequency character)	Reference frequency setting 5~600 Hz, multipoint V/F curve setting, or fixed curve of constant torque, low decreasing torque 1, low decreasing torque 2, square torque	
		Torque Compensation	Manual setting: 0.0~30% of rated output Automatic compensation: according to output current and motor parameter	
		Automatic Current-limiting and Voltage-limiting	During acceleration, deceleration or steady running, detect automatically the current and voltage of motor stator, and control it within bounds based on unique algorithm, minimize fault-trip chance	
	Senseless Vector Control	Voltage Frequency	Adjust pressure/frequency ratio according to motor parameter and unique algorithm	
		Torque Character	Starting torque: 3.0 Hz 150% rated torque (VF control) 0.5 Hz 180% rated torque (SVC, FVC) 0.05 Hz 180% rated torque (VC) Operating speed precision in steady state: $\leq \pm 0.5\%$ rated synchronous speed Torque response: $\leq 50\text{ms}$ VC, SVC, FVC $\leq 20\text{ms}$	
		Motor Parameter Self-measurement	Being able to detect parameter automatically under static state and dynamic state of motor, thus guarantee an optimum control.	
		Current and Voltage Restrain	Current closed-loop control, free from current impact, perfect restrain function of overcurrent and overvoltage	
	Undervoltage Restrain during	Specially for users with a low or unsteady voltage power grid: even lower than the allowable voltage range, the system can maintain the longest possible operating time based on its unique algorithm and residual energy allocation		
	Typical	Multi-velocity and Traverse	16 segments programmable multi-velocity control, multiple operation mode. Traverse operation: preset frequency and center frequency adjustable, parameter memory and recovery after power cut.	

Specification

PID Control RS485 Communication		Built-in PID controller (able to preset frequency). Standard configuration RS485 communication function, multiple communication protocol for choice, synchronizing control function.
Frequency Setting	Analog Input	Direct voltage 0~10V, direct current 0~20mA (optional up limit and lower limit)
	Digital Input	Operation panel setting, RS485 port setting, UP/DW terminal control, or combined with analog input
Output Signal	Digital Input	2 channel OC output and one channel relay output (TA, TB, TC), up to 16 choices
	Analog Input	2 channel analog signal output, output ranging within 0~20mA or 0~10V with flexibly setting, achievable output of physical quantities like set frequency, output frequency
Automatic Steady-voltage Operation		Dynamic steady state, static steady state, and unsteady voltage for choices to obtain the steadiest operation
Acceleration and		0.1s~3600min continuous setting, S type and linear type mode for choice
Time Setting		
Brake	Dynamic	Dynamic braking initial voltage, backlash voltage and dynamic braking continuous adjustable
	DC Braking	Halt DC braking initial frequency: 0.00~[F0.16] upper limit frequency Braking time: 0.0~100.0s; Braking current: 0.0%~150.0% of rated current
	Flux Restrain	0~100 0: invalid
Low Noise Running		Carrier frequency 1.0kHz~16.0kHz continuous adjustable, minimize motor noise
Speed Tracking and Restart		Smooth restart during operation, instantaneous stop and restart
Counter		A built-in counter, facilitate system integration
Operation Function		Upper limit and lower limit frequency setting, frequency hopping operation, reversal running restraint, slip frequency compensation, RS485 communication, frequency control of progressive increase and decrease, failure recovery
Display	Operating State	Output frequency, output current, output voltage, motor speed, set frequency, module temperature, PID setting, feedback, analog input and output.

Specification

	Alarm	The latest 6 faults record; running parameters record when the latest fault tripping happens including output frequency, set frequency, output current, output voltage, DC voltage and module temperature.
Protective Function		Overcurrent, overvoltage, undervoltage, module fault, electric thermal relay, overheat, short circuit, default phase of input and output, motor parameter adjustment abnormality, internal memory fault, etc.
Environment	Ambient Temperature	-10℃~+40℃ (please run the VFD in derated capacity when ambient temperature is 40℃)
	Ambient Humidity	5%~95%RH, without condensing drops
	Surroundings	Indoors (without direct sunlight, corrosive or flammable gas, oil fog and dust)
	Altitude	Running in derated capacity above 1000m, derate 10% for every 1000m rise.
Structure	Protection Level	IP20
	Cooling	Air cooling with fan control
Installation		Wall-hanging type, cabinet type

2.2 Chassis and keyboard dimensions

Chassis size:

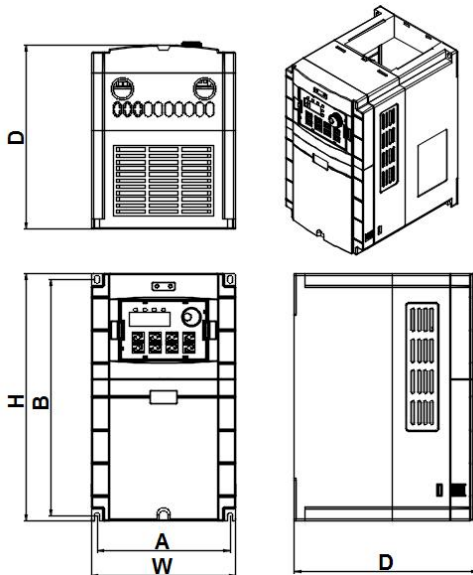

FigureD-1 Frequency converter 0.75KW~315KW external dimensions

Model	A (mm)	B (mm)	H (mm)	W (mm)	D (mm)	Mounting hole (mm)
	Installation size		Peripheral dimension			
0.75KW-2.2KW W	89	140	151	100	133	5
4.0KW-7.5KW W-11KW	131	229	239	140	177	5
15KW-22KW	189	306	320	205	205	6
30KW-37KW	235	447	463	285	228	8
45KW-55KW	235	485	510	320	248	8
75KW-110KW W	240	635.5	655	377	267	8

Keyboard installation dimensions:

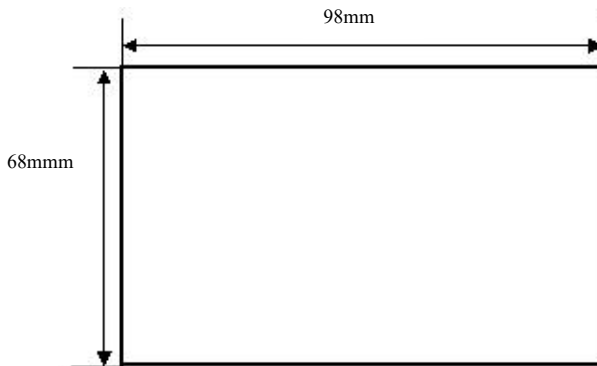

External keyboard installation dimensions (open - hole dimensions)

2.3 Rated current output table

Voltage	single - phase	three - phase	
	220V	220V(240V)	380V(415V)
PowerKW)	current A)	current (A)	current (A)
0.4	2.3	2.3	-
0.75	4	4	2.1
1.5	7	7	3.8
2.2	9.6	9.6	5.1
4	17	17	8.5

Specification

5.5	25	25	13
7.5	-	-	16
11	-	-	24
15	-	-	32
18.5	-	-	36
22	-	-	44
30	-	-	58
37	-	-	70
45	-	-	90
55	-	-	110
75	-	-	152
93	-	-	172
1 10	-	-	205
132	-	-	253
160	-	-	304
200	-	-	380
220	-	-	426
250	-	-	465
280	-	-	520
315	-	-	585
355	-	-	650
400	-	-	725
450	-	-	820

2.4 Selection of braking resistor

Voltage (V)	Converter power (KW)	Brake resistor specification		braking torque
		W	Ohm	10%ED
Single - phase 220 series	0.4	80	200	125
	0.75	80	150	125
	1.5	100	100	125
	2.2	100	70	125
	4.0	300	50	125
Three - phase 220 series	0.75	150	110	125
	1.5	250	100	125
	2.2	300	65	125
	4	400	45	125
	5.5	800	22	125
Three - phase 380 series	7.5	1000	16	125
	0.75	100	750	125
	1.5	300	400	125
	2.2	300	250	125
	4	400	150	125
	5.5	500	100	125
	7.5	1000	75	125
	11	3000	43	125
	15	3000	32	125
	18.5	3000	25	125
	22	4000	22	125
	30	5000	16	125
	37	6000	13	125
45	6000	10	125	
55	6000	10	125	
75	7500	6.3	125	

Specification

Voltage (V)	Converter power (KW)	Brake resistor specification		braking torque
		W	Ohm	10%ED
	93	9000	9.4/2	125
	110	11000	9.4/2	125
	132	13000	6.3/2	125
	160	16000	6.3/2	125
	200	20000	2.5	125
	220	22000	2.5	125
	250	25000	2.5/2	125
	280	28000	2.5/2	125
	315	32000	2.5/2	125
	355	34000	2.5/2	125
	400	42000	2.5/3	125
	450	45000	2.5/3	125

Note:

1. please select the resistance value specified by the company.
2. if the brake resistance provided by the company is used, and causes the frequency converter or other equipment to be damaged, the company shall not bear any responsibility.
3. the installation of brake resistance must consider the safety of the environment, flammability, distance frequency converter at least 100 mm.
4. the parameters in the table are for reference only and not as standard.

3. Basic Running Wiring

3.1 Basic wiring diagram

The wiring parts of VFD include major loop and control loop. Open the cover of I/O terminals, users can see the major loop terminal and control loop terminal, and must conduct the wiring according to the following diagram.

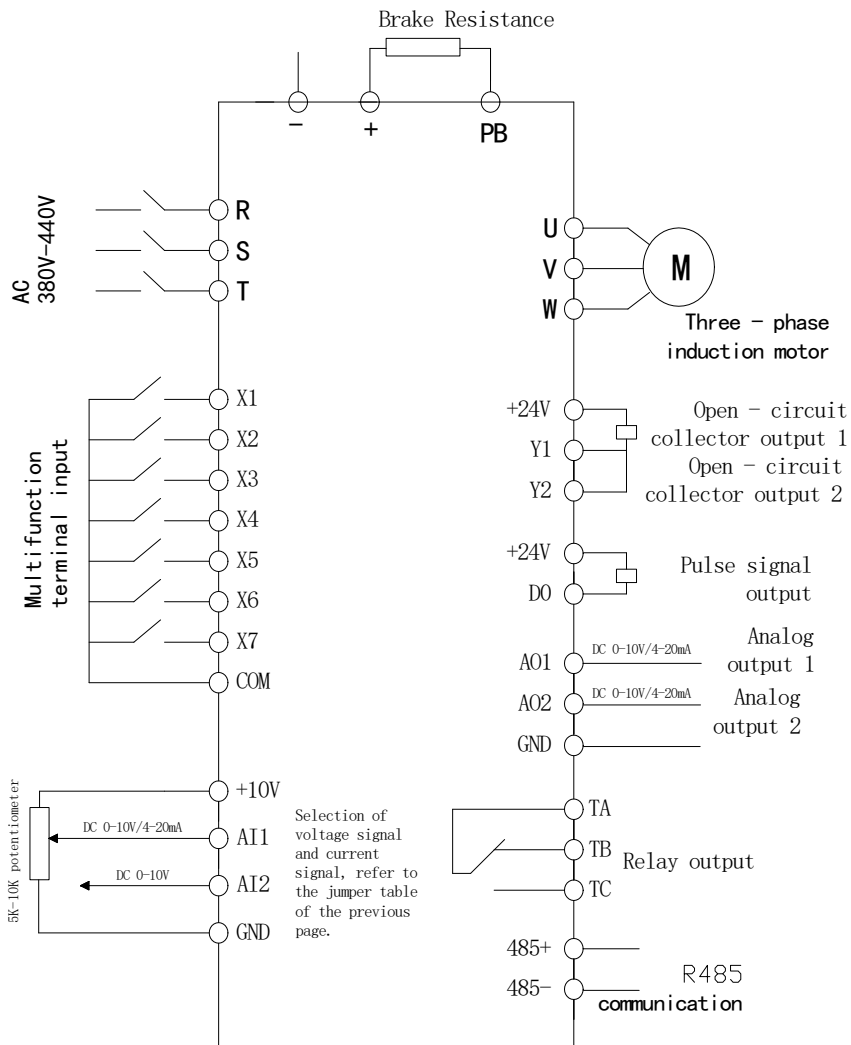

	TB1/TB2		
	TC1/TC2		
Power Port	+24V	24V is the common power for circuits of all digital signal input terminals.	Maximum output current 200mA

▲ Control terminal AI1 can input both voltage and current signal, while AI2 can only input voltage signal; users can conduct corresponding jumper on master control board according to signal type.

▲ Connecting weak analog signal is easily affected by external disturbance. So wiring should be as short as possible. The external control line should be set with isolating device or shielding line, and should be grounded.

▲ Input order signal line and frequency meter should be wired separately with shielding, and away from major loop wiring.

▲ Control loop wiring should be over 0.75 mm^2 , and STP (shielded twisted pair) is recommended. The connecting part of control loop terminals should be enameled with tin, or process metal joint with cold pressing.

▲ While connecting analog signal output devices, malfunction may occur because of interference from VFD, which can be solved by fixing with capacitor or ferrite bead to the analog signal output device.

3.4 Dial Switch

JP2	
OFF	The resistance of the matching on the 485 communication is not connected
ON	The resistance of the matching on the 485 communication is connected
JP3	
C _{in}	Represents AI1 input current signal, 4 - 20mA
V _{in}	Represents AI1 input voltage signal, 0 - 10v
JP4	
V _{o1}	Represents the AO1 output voltage signal, 0 - 10v
Co1	Represents AO1 output current signal, 4 - 20mA
JP5	
AO2	The AO2 / DO2 AO2 is effective and the output voltage signal is output
DO	The do is valid for the AO2 / DO, and the output pulse signal is output
JP7	
V _{o2}	The output voltage signal of the AO2 is 0 - 10 v
Co2	Represents the AO2 output current signal, 4 - 20mA

3.5 Wiring Notices

- ① Cut off the input power of VFD while dismantling and changing the motor.
- ② Switching of motor or work frequency power supply should only be conducted when the VFD stops output.
- ③ To reduce the effect of EMI (electromagnetic interference), add a surge absorber when electromagnetic connector and relay are close to VFD.
- ④ Do not connect AC input power to output terminal U, V, W of VFD.
- ⑤ Add an isolating device to the external control line or use shield line.

- ⑥ Input order signal line should be wired separately with shielding, and away from major loop wiring.
- ⑦ When carrier frequency is less than 4kHz, keep the distance between VFD and motor within 50m; when carrier frequency exceeds 4kHz, make an appropriate reduction of the distance, and better lay the wire in metal tube.
- ⑧ When adding peripherals (filters, reactors, etc.) to the VFD, check the ground resistance with 1000V tramegger and ensure the value is above 4 M Ω .
- ⑨ Do not add phase advance capacitor or RC snubber to the U, V, W terminal of VFD.
- ⑩ If the VFD starts frequently, do not cut off the power, use the COM/RUN of control terminal to conduct start and stop so as not to damage the rectifier bridge.

The earth terminal must be grounded reliably (grounding impedance should be under 100 Ω) to avoid accidents, or there might be electric leakage.

Choose the wire diameter according to national electrical code while conducting major loop wiring.

Spare Circuit

It may cause big downtime loss or other accidental failure during VFD failure or tripping. Adding spare circuit is recommended under this circumstance to ensure safety. Note: confirm and test the operation characteristic of the spare circuit in advance to ensure the working frequency and the phase sequence of converted frequency are agreed.

4.Operation and display

4.1 Operating panel



4.2 Operation Panel Keys

Key	Name	Function Description
PRG	programming /escape key	Enter or escape from programming
ENTER	Enter key	Enter into sub-menu items or confirm data.
▲	Increase key	Data or function code increase (speed up the increasing rate by keeping pressing the key)
▼	Decrease key	Data or function code decrease (speed up the decreasing rate by keeping pressing the key)
▶	shift/monitor key	Choose the bit of the data which is to be set and modified when the VFD is in edit status; switch monitor parameter to be shown when the VFD is in other modes.
RUN	Run key	Enter into run mode under keypad model.
STOP/RESET	stop/reset key	In common run status the VFD will be stopped according to set mode after press this key if run command channel is set as keyboard stop effective mode. The VFD will be reset and resume normal stop status after pressing this key when the VFD is in malfunction status.
MF.K	Function key	According to the setting of function parameter FE.01, jog or reverse run, and frequency clearance is available when pressing this key under keypad mode.

4.3 LED and Indicator Light Description :

Item		Function Description	
Display Function	Digital Display	Display current run status parameter and set parameter.	
	LED Indicator	Hz, A, V	isplayed physical quantity unit (current A, voltage V, frequency Hz)
		ALM	Alarm indicator light, indicate that the VFD is in over current or over voltage suppressing status or failure alarm status currently.
		FWD	This indicator light turns green when the VFD is in forward running status.
		REV	This indicator light turns red when the VFD is in reverse running status.
		REMOTE	Remote control indicator.
LED Indicator	A	Current displayed parameter is current with unit of A, LED indicator light A	
	V	Current displayed parameter is voltage with unit of V, LED indicator light V	
	Hz	Current displayed parameter is frequency with unit of Hz, LED indicator light Hz is on	
	%	Current displayed parameter is percentage, LED indicator light Hz and V are on	
	r/min	Current displayed parameter is rotational speed, LED indicator light Hz and A are on	
	m/s	Current displayed parameter is linear velocity, LED indicator light V and A are on	
	°C	Current displayed parameter is temperature, LED indicator light V, A and Hz are on	

5.Function Code

○—modifiable parameter under any condition

×—not modifiable parameter under run status

◆—the actual detected parameter, not modifiable

◇—factory parameter, only modifiable for factory, not allowed for users modifying

Function Code	Name	Set Range	Factory Default	Modification
F0 Group - Basic Run Parameters				
F0.00	VFD type	0: G type (constant torque load type) 1: P type (fan, water pump load type) Note 1 set as P type, and the VFD parameters will refresh automatically, without modifying any parameter the VFD can be used as inverter of higher grade for application of fan and water pump. Note2: can not be initialized, please modify it manually.	0	×
F0.01	Control mode	0: common V/F control (manually torque boost) 1: advanced V/F control (automatically torque boost) 2: open loop current vector control (SVC) 3: separatd type V/F control Note 1: choose control method 3(closed loop current vector control),input terminal X6 can only be used for ordinary terminal, not for high-speed pulse input. Note2:this parameter can not be initialized, please modify it manually.	Dependi ng on model	×
F0.02	Operation command channel	0: operation panel run command channel 1: terminal run command channel 2: communication run command channel	0	○
F0.03	Main frequency source A	0: digital set 1 (keypad ▲/▼ key,) 1: digital set 2 (terminal UP/DOWN) 2: AI1 analog set (0~10V/20mA) 3: AI2 analog set (0~10V) 4: panel Potentiometer 5: pulse set (0~50KHZ) 6: multistage speed run set 7: easy PLC set 8: PID control set 9: digital set 3 (communication set)	0	○
F0.04	Main frequency source B	0: digital set 1 (keypad ▲/▼ key,) 1: digital set 2 (terminal UP/DOWN) 2: AI1 analog set (0~10V/20mA) 3: AI2 analog set (0~10V) 4: panel Potentiometer 5: pulse set (0~50KHZ) 6: multistage speed run set 7: easy PLC set 8: PID control set 9: digital set 3 (communication set)	2	○

Function Code	Name	Set Range	Factory Default	Modification
F0.05	Frequency source	0: main frequency source A 1: A+K*B 2: A-K*B 3: A-K*B 4: MAX (A, K*B) 5: MIN (A, K*B) 6switch from A to K*B (A prior to K*B) 7switch form A to (A+K*B) (A prior to A+K*B) 8: switch form A to (A-K*B) (A prior to A-K*B) Note 1: frequency switch needs Note 2: compared with frequency source set method, traverse operation has a higher priority.	0	○
F0.06	Frequency source digital setting 1	0.00Hz~【F0.11】 upper limit of frequency	50.00	○
F0.07	Frequency source digital setting 2	0.00Hz~【F0.11】 upper limit of frequency	50.00	○
F0.08	Auxiliary frequency source weight coefficient K setting	0.01~10.00	1.00	○
F0.09	Running direction	0: forward 1: reverse 2: prevent reversing	0	×
F0.10	Maximum output frequency	Low frequency range: MAX {50.00, 【F0.11】} ~ 300.00 High frequency range: MAX {50.00, 【F0.11】} ~ 3000.0	50.00	×
F0.11	Upper limit frequency	【F0.12】~【F0.10】	50.00	×
F0.12	Lower limit frequency	0.00Hz~【F0.11】	0.00	×
F0.13	Carrier frequency	1.0~16.0KHz 0.4~4.0KW 6.0KHz 1.0~16.0KHz 5.5~30KW 4.5KHz 1.0~16.0KHz 37~132KW 3.0KHz 1.0~10.0KHz 160~630KW 1.8KHz 1.0~5.0 KHz		○
F0.14	Acceleration time 1	0.1 ~ 3600.0S 0.4 ~ 4.0KW 7.5S 5.5 ~ 30.0KW 15.0S		○
F0.15	Deceleration time 1	37.0 ~ 132.0KW 30.0S 160.0~ 630.0KW 60.0S		○
F0.16	Digital set 1 control	LED ones digit: power down storage 0: storage 1: not storage LED tens digit: hold when stop 0: hold 1: not hold	000	○
F0.17	Digital set 2 control	LED hundred digit: ▲/▼ key, UP/DOWN frequency 0: invalid 1: valid LED thousands digit: reserved	000	○
F1 Group - Motor Parameters				
F1.00	Motor type	0: AC asynchronous motor 1: PMSM (reserved)	0	×

Function Code	Name	Set Range	Factory Default	Modification
		Note 1: only closed-loop vector control is acceptable by synchronous machine at present Note 2: this parameter can not be initialized, please modify it manually.		
F1.01	Motor's rated power	0.4~999.9KW		×
F1.02	Motor's rated freq.	0.01Hz~ 【F0.10】 maximum freq	50.00	×
F1.03	Motor's rated speed	0~60000RFM		×
F1.04	Motor's rated voltage	0~999V		×
F1.05	Motor's rated current	0.1~6553.5A		×
F1.06	Stator resistance of asynchronous motor	0.001~20.000Ω		×
F1.07	Rotor resistance of asynchronous motor	0.001~20.000Ω		×
F1.08	Stator and rotor inductance of asynchronous motor	0.1~6553.5mH		×
F1.09	Stator and rotor mutual inductance of asynchronous motor	0.1~6553.5mH		×
F1.10	No-load current of asynchronous motor	0.01~655.35A		×
F1.11-F1.15	Reserved	—	0	◆
F1.16	Motor tuning	0: no action 1: no-load complete tuning 2: on-load complete tuning	0	×
F2 Group - Speed Loop, Torque and Flux Control Parameters				
F2.00	Speed loop (ASR1) proportional	0.000~6.000	1.000	○
F2.01	Speed loop (ASR1) integral time	0.000~32.000S	1.000	○
F2.02	ASR1 filter time constant	0.000~0.100S	0.000	○
F2.03	Switch low point freq.	0.00Hz~ 【F2.07】	5.00	○
F2.04	Speed loop (ASR2) proportional gain	0.000~6.000	1.500	○
F2.05	Speed loop (ASR2) integral time	0.000~32.000S	0.500	○
F2.06	ASR2 filter time constant	0.000~0.100S	0.000	○
F2.07	Switch high point freq	【F2.03】 ~ 【F0.11】 upper limit freq.	10.00	○
F2.08	Vector control of positive slip compensation factor (electromotion state)	50.0%~200.0%* rated slip frequency	100.0%	○
F2.09	Vector control of negative slip compensation factor (braking state)	50.0%~200.0%* rated slip frequency	100.0%	○

Function Code	Name	Set Range	Factory Default	Modification
F2.10	Speed and torque control	0: speed 1: torque 2: valid conditionally (terminal switch)	0	×
F2.11	Speed and torque switching delay	0.01~1.00S	0.05	×
F2.12	Torque command	0: keypad set 1: AI1 2: AI2 3: communication set	0	○
F2.13	Torque set by keypad	-200.0%~200.0%* rated current of motor	0.0%	○
F2.14	Speed limit channel 1 of torque control mode (forward)	0: keypad set 1 1: AI1 2: AI2	0	○
F2.15	speed limit channel 1 of torque control mode (reverse)	0: keypad set 2 1: AI1 2: AI2	0	○
F2.16	Keypad limit speed 1	0.0~100.0%* 【F0.10】 maximum freq.	100.0%	○
F2.17	Keypad limit speed 2	0.0~100.0%* 【F0.10】 maximum freq.	100.0%	○
F2.18	Torque rise time	0.0~10.0S	0.1	○
F2.19	Torque decline time	0.0~10.0S	0.1	○
F2.20	Electromotion torque limit of vector mode	G type: 0.0%~200.0%*rated current of motor 180.0% P type: 0.0%~200.0%*rated current of motor 120.0%		○
F2.21	braking torque limit of vector mode	G type: 0.0%~200.0%*rated current of motor 180.0% P type: 0.0%~200.0%*rated current of motor 120.0%		○
F2.22	Torque detection action	0: detect invalid 1: keep running after over torque detected during constant speed 2: keep running after over torque detected during running 3: cut off output after over torque detected during constant speed 4: cut off output after over torque detected during running 5: keep running after torque shortage detected during constant speed 6: keep running after torque shortage detected during running 7: cut off output after torque shortage detected during constant speed 8: cut off output after torque shortage detected during running	0	×

Function Code	Name	Set Range	Factory Default	Modification
F2.23	Torque detection level	G type: 0.0%~200.0%*rated current of motor 150.0% P type: 0.0%~200.0%*rated current of motor 110.0%		×
F2.24	Torque detection time	0.0~10.0S	0.0	×
F2.25	Cut off freq. of static friction coefficient	0.00~300.00Hz	10.00	○
F2.26	Static friction coefficient set	0.0~200.0	0.0	○
F2.27	Hold time of static friction coefficient	0.00~600.00s	0.00	×
F3 Group - VF Control Parameters				
F3.00	V/F curve set	0: linear curve 1: decreasing torque curve 1(1.3 power) 2: decreasing torque curve 2(1.5 power) 3: decreasing torque curve 3(1.7 power) 4: square curve 5: user set V/F curve (determined by F3.03~F3.08)	0	×
F3.01	Torque boost setting	0.0~30.0%*rated voltage of motor 【F1.02】		×
F3.02	Torque boost cutoff point	0.00~rated freq. of motor	15.00	×
F3.03	V/F frequency F1	0.00~F2 (frequency value)	12.50	×
F3.04	V/F voltage V1	0.0~V2 (voltage value)	25.0%	×
F3.05	V/F frequency F2	F1~F3 (frequency value)	25.00	×
F3.06	V/F voltage V2	V1~V3 (voltage value)	50.0%	×
F3.07	V/F frequency F1	0.00~F2 (frequency value)	37.50	×
F3.08	V/F frequency F3	Freq. Value F2~ 【F1.02】 rated freq. of motor	75.0%	×
F3.09	V/F control slip frequency compensation	0.0~200.0%*rated slip note: default as 100.0% in advanced VF control mode	0.0%	○
F3.10	V/F control slip compensation filtering coefficients	1~10	3	○
F3.11	V/F control torque compensation filtering coefficients	0~10		○
F3.12	Separated type V/F control	0: VF half separated mode, voltage open-loop output 1: VF half separated mode, voltage closed-loop output 2: VF complete separated mode, voltage open-loop output 3: VF complete separated mode, voltage closed-loop output Note 1: when choose VF separated control, please close the dead-time compensation function Note 2 half separated concept is based on that during start-up the frequency and voltage of	0	×

Function Code	Name	Set Range	Factory Default	Modification
		VFD remains the VVVF relation, but get separated after the reaching of set frequency		
F3.13	Voltage setting channel	0: digital setting 1: AI1 2: AI2	0	○
F3.14	Output voltage of digital setting	0.0~200.0%*rated voltage of motor note:in open loop output mode, the maximum output voltage is 100.0% of rated voltage of motor	100.0%	○
F3.15	VF curve max. voltage of half separation mode	0.0~100.0%*rated voltage of motor note: this voltage represents output voltage of VFD	80.0%	×
F3.16	Voltage rising time	0.1~3600.0s	10.0	○
F3.17	Voltage declining time	note:this parameter is only valid for open loop output mode of complete separated voltage	10.0	○
F4 Group - Digital Input Parameters				
F4.00	Input X1 function (when FA.21 is non-zero, default as function NO.58)	0: control terminal idle 1: forward run (FWD) 2: reverse run (REV) 3: three-wire running control 4: forward jog control 5: reverse jog control 6: free shutdown control	1	×
F4.01	Input X2 function (when FA.21 is non-zero,default as function NO.59)	7: external reset signal input(RST) 8: external fault normally-open input 9: external fault normally-close input 10: emergency stop function (brake with) 11: reserved 12: freq. increase 13: freq. decrease 14: UP/DOWN terminal freq. zero clearing 15: multi-speed 1 16: multi-speed 2	2	×
F4.02	Input X3 function (when FA.21 is non-zero, default as function NO.60)	17: multi-speed 3 18: multi-speed 4 19: ACC/DEC time TT1 20: ACC/DEC time TT2 21: run command channel 1 22: run command channel 2 23: VFD ACC/DEC prohibit 24: VFD operation prohibiting	4	×
F4.03	Input X4 function (when FA.21 is non-zero, default as function NO.61)	25: run command switch to keypad 26: run command switch to terminal 27: run command switch to communication 28: auxiliary freq. zero clearing 29: freq. source A and K*B switch 30: freq. source A and A+K*B switch 31: freq. source A and A-K* B switch 32: reserved	7	×

Function Code	Name	Set Range	Factory Default	Modification
F4.04	Input X5 function (when FA.21 is non-zero, default as function NO.62)	33: PID control input 34: PID control pause 35: start traverse operation 36: pause traverse operation 37: traverse status reset 38: PLC control input	8	×
F4.05	Input X6 function (when FA.21 is non-zero, default as function NO.63)	39: PLC pause 40: PLC reset 41: clear the counter to zero 42: input signal to trigger the counter 43: timing triggering input 44: timing clearing input 45: input external impulse frequency (only valid for X6)	0	×
F4.06	Input X7 function	46: clear the length information 47: input the signal of length (only valid for X6) 48: switch speed and torque control 49: prohibit torque control 50~55: reserved 56~57: reserved 58: start/stop 59: running allowed 60: interlock1 61: interlock2 62: interlock3 63: PFC start/stop 64: A frequency switch B and run 65~99: reserved	45	×
F4.07	reserved	—	0	◆
F4.08	Digital filtering times	1~10 1: 2MS unit of scanning time	5	○
F4.09	Terminal function detection when power on	0: terminal operation command invalid when power on 1: terminal operation command valid when power on	0	○
F4.10	Effective logic setting of input terminal (X1 ~ X7)	0~7FH 0 is positive logic, i.e. terminal Xi is enabled when it connects with common terminal and disabled if disconnected. 1 is negative logic, i.e. terminal Xi is disabled when it connects with common terminal and enabled when disconnected.	00	×
F4.11	FWD/REV terminal control mode	0: two-wire control mode 1 1: two-wire control mode 2 2: three-wire control mode 1 3: three-wire control mode 2	0	×
F4.12	UP/DOWN terminal frequency modifying rate	0.01~50.00Hz/S	1.00	○
F4.13	All input lower-limit	0.00V/0.00mA~10.00V/20.00mA	0.00	○
F4.14	All lower limit corresponding physical quantity set	-200.0%~200.0% note: range is relevant to F4.28	0.0%	○
F4.15	All input upper limit	0.00V/0.00mA~10.00V/20.00mA	10.00	○
F4.16	All upper limit	-200.0%~200.0%	100.0%	○

Function Code	Name	Set Range	Factory Default	Modification
	corresponding physical quantity setting	note: range is relevant to F4.29		
F4.17	AI1 input smoothing time	0.00S~10.00S	0.05	○
F4.18	AI2 input lower limit	0.00V~10.00V	0.00	○
F4.19	AI2 lower limit corresponding physical quantity setting	-200.0%~200.0% note: range is relevant to F4.28	0.0%	○
F4.20	AI2 input upper limit	0.00V~10.00V	10.00	○
F4.21	AI2 upper limit corresponding physical quantity setting	-200.0%~200.0% note: range is relevant to F4.29	100.0%	○
F4.22	AI2 input filtering time	0.00S~10.00S	0.05	○
F4.23	External impulse input lower limit	0.00~50.00kHz	0.00	○
F4.24	external impulse lower limit corresponding physical quantity set	-200.0%~200.0% note: range is relevant to F4.30	0.0%	○
F4.25	external impulse input upper limit	0.00~50.00kHz	50.00	○
F4.26	external impulse upper limit corresponding physical quantity set	-200.0%~200.0% note: range is relevant to F4.30	100.0%	○
F4.27	external impulse input filtering time	0.00S~10.00S	0.05	○
F4.28	AI1 input corresponding physical quantity	0: speed command (output freq., -100.0%~100.0%) 1: torque command (output torque, -200.0%~200.0%) 2: voltage command (output voltage, 0.0%~200.0% *rated voltage of motor)	0	×
F4.29	AI2 input corresponding physical quantity	0: speed command (output freq., -100.0%~100.0%) 1: torque command (output torque, -200.0%~200.0%) 2: voltage command (output voltage, 0.0%~200.0% *rated voltage of motor)	0	×
F4.30	External impulse input corresponding physical quantity	0: speed command (output freq., -100.0%~100.0%) 1: torque command (output torque, -200.0%~200.0%)	0	×
F4.31	Error limit of analog input	0.00V~10.00V	0.00	○
F4.32	Threshold of zero freq. operation	Zero freq. hysteresis~50.00Hz	0.00	○
F4.33	zero freq. hysteresis	0.00~zero freq. threshold value	0.00	○
F4.34	AI Multi - point curve selection	LED ones digit: AI1 Multi - point curve selection 0: invalid 1: valid LED tens digit: AI2 Multi - point curve selection 0: invalid 1: valid LED hundred digit: reserved, LED thousands digit: reserved	00	×
F4.35	AI1 Minimum - curve input	0.00~【F4.37】	0.00	○
F4.36	AI1 Minimum input corresponding to the curve	-200.0%~200.0% note: range is relevant to F4.28	0.0%	○
F4.37	AI1 Curve inflection point	【F4.35】~【F4.39】	3.00	○

Function Code	Name	Set Range	Factory Default	Modification
	1 input			
F4.38	A11 Curve inflection point 1, enter the corresponding setting	-200.0%~200.0% note: range is relevant to F4.28	30.0%	○
F4.39	A11 Curve inflection point 2 input	【F4.37】 ~ 【F4.41】	6.00	○
F4.40	A11 Curve inflection point 2, enter the corresponding setting	-200.0%~200.0% note: range is relevant to F4.28	60.0%	○
F4.41	A11 Max. curve input	【F4.39】 ~10.00	10.00	○
F4.42	A11 The maximum input corresponds to the setting of the curve	-200.0%~200.0% note: range is relevant to F4.28	100.0%	○
F4.43	A12 Minimum - curve input	0.00~ 【F4.45】	0.00	○
F4.44	A12 Minimum input corresponding to the curve	-200.0%~200.0% note: range is relevant to F4.29	0.0%	○
F4.45	A12 Curve inflection point 1 input	【F4.43】 ~ 【F4.47】	3.00	○
F4.46	A12 Curve inflection point 1, enter the corresponding setting	-200.0%~200.0% note: range is relevant to F4.29	30.0%	○
F4.47	A12 Curve inflection point 2 input	【F4.45】 ~ 【F4.49】	6.00	○
F4.48	A12 Curve inflection point 2, enter the corresponding setting	-200.0%~200.0% note: range is relevant to F4.29	60.0%	○
F4.49	A12 Max. curve input	【F4.47】 ~10.00	10.00	○
F4.50	A12 The maximum input corresponds to the setting of the curve	-200.0%~200.0% note: range is relevant to F4.29	100.0%	○
F4.51	reserved	—	0	◆
F5 Group - Digital Output Parameters				
F5.00	Open collector output terminal Y1	0: no output 1: VFD forward running 2: VFD reverse running 3: fault output 4: freq./speed level detection signal (FDT1) 5: freq./speed level detection signal (FDT2) 6: freq./speed arrival signal (FAR) 7: VFD zero-speed running 8: upper limit arrival of output freq. 9: lower limit arrival of output freq. 10: lower limit arrival of preset freq. during running 11: pre-alarm signal of overload 12: counter detection signal output 13: counter detection reset signal output 14: driver ready 15: one cycle finished of programmable MS running 16: stage finished of programmable MS running 17: upper and lower limit of traverse freq. 18: current limiting action	0	×
F5.01	Open collector output terminal Y2		0	×
F5.02	Programmable relay R1 output		3	×
F5.03	Programmable relay R2 output		0	×

Function Code	Name	Set Range	Factory Default	Modification
		19: stall over voltage 20: low voltage lock-up 21: dormancy state 22: VFD alarm signal (PIDdisconnection, RS485 communication failure, panel communication failure, EEPROM read-write failure, encoder disconnection, etc.) 23: AI1 > AI2 24: preset length arrival 25: preset operation time out 26: dynamic braking action 27: DC braking action 28: flux braking action 29: torque limiting 30: over torque signal 31: auxiliary motor 1 32: auxiliary motor 2 33: accumulated operation time out 34~49: segment of MS or simple PLC operation 50: running indication signal 51: temperature arrival indication 52~99: reserved		
F5.04	AO1 multi-function analog output terminal	0: output frequency (before slip compensation)	0	○
F5.05	AO2 multi-function analog output terminal	1: output frequency (after slip compensation) 2: set frequency 3: motor speed (estimated value)	4	○
F5.06	DO multi-function impulse output terminal	4: output current 5: output voltage 6: but voltage 7: PID specified value 8: PID feedback value 9: AI1 10: AI2 11: input pulse freq. 12: torque current 13: flux current	11	○
F5.07	Physical quantity correspond to AO1 output lower limit	-200.0%~200.0%	0.0%	○
F5.08	AO1 output lower limit	0.00~10.00V	0.00	○
F5.09	Physical quantity correspond to AO1 output upper limit	-200.0%~200.0%	100.0%	○
F5.10	AO1 output upper limit	0.00~10.00V	10.00	○
F5.11	Physical quantity correspond to AO2 output lower limit	-200.0%~200.0%	0.0%	○
F5.12	AO2 output lower limit	0.00~10.00V	0.00	○
F5.13	Physical quantity correspond to AO2 output upper limit	-200.0%~200.0%	100.0%	○

Function Code	Name	Set Range	Factory Default	Modification
F5.14	AO2 output upper limit	0.00~10.00V	10.00	○
F5.15	Physical quantity correspond to DO output lower limit	-200.0%~200.0%	0.0%	○
F5.16	DO output lower limit	0.00~50.00kHz	0.00	○
F5.17	Physical quantity correspond to DO output upper limit	-200.0%~200.0%	100.0%	○
F5.18	DO output upper limit	0.00~50.00kHz	50.00	○
F5.19	Logic setting of output terminal (Y1~Y2)	0~3H 0: positive logic, i.e. terminal Yi is enabled when it connects with common terminal, and disabled if disconnected. 1: negative logic, i.e. terminal Yi is disabled when it connects with common terminal, and enabled if disconnected.	0	×
F5.20	Y1 output delay time	0.0~100.0s	0.0	×
F5.21	Y2 output delay time	0.0~100.0s	0.0	×
F5.22	R1 output delay time	0.0~100.0s	0.0	×
F5.23	R2 output delay time (reserved)	0.0~100.0s	0.0	×
F5.24	Y1 turn off delay time	0.0~100.0s	0.0	×
F5.25	Y2 turn off delay time	0.0~100.0s	0.0	×
F5.26	R1 turn off delay time	0.0~100.0s	0.0	×
F5.27	R2 turn off delay time	0.0~100.0s	0.0	×
F6 Group - Auxiliary Operating Parameters				
F6.00	Start mode	0: start at start frequency 1: DC braking + start at start frequency 2: start with speed tracking	0	×
F6.01	Start frequency	0.00~50.00Hz	1.00	○
F6.02	Start frequency hold time	0.0~100.0s	0.0	○
F6.03	DC brake current at startup	0.0~150.0%*rated current of motor	0.0%	○
F6.04	DC brake time at startup	0.0~100.0s	0.0	○
F6.05	Accelerating and decelerating mode	0: linear Acc/Dec mode 1: S curve Acc/Dec mode	0	×
F6.06	Time ratio of initial segment in S curve	10.0~50.0%	20.0%	○
F6.07	Time ratio of ending segment in S curve	10.0~50.0%	20.0%	○
F6.08	Stop mode	0: Decelerate to stop 1: coast to stop	0	×
F6.09	Frequency threshold of DC brake	0.00~【F0.11】 upper limit frequency	0.00	○

Function Code	Name	Set Range	Factory Default	Modification
F6.10	DC brake delay time	0.0~100.0s	0.0	○
F6.11	DC brake current	0.0~150.0%*rated current of motor	0.0%	○
F6.12	DC brake time at stop	0.0~100.0s	0.0	○
F7 Group – Panel Function Setting and Parameter Management				
F7.00	Key M-FUNC function	0: JOG (jog control) 1: FWD/REV switch 2: clear frequency set by ▲/▼ 3: switch between local operation and remote control (reserved) 4: reverse	0	×
F7.01	Key STOP/RST function	0: only effective to panel control 1: effective to both panel and terminal control 2: effective to both panel and communication control 3: effective to all control modes	3	○
F7.02	Monitoring parameter selection 1 in operation status	0~57	0	○
F7.03	Monitoring parameters selection 2 in operation status	0~57	5	○
F7.04	Monitoring parameters selection 1 in stop status	0~57	1	○
F7.05	Monitoring parameters selection 2 in stop status	0~57	13	○
F7.06	Close-loop display factor	0.01~100.00	1.00	○
F7.07	Display factor of load rotating speed	0.01~100.00	1.00	○
F7.08	Line speed factor	0.01~100.00	1.00	○
F7.09	STOP + RUN emergency stop	0: disabled 1: coast to stop	1	○
F7.10	Encoder regulation speed (served)	1~100	70	○
F7.11	Parameter display mode	LED one's place: function parameters display mode 0: display all function parameters 1: only display parameters different from default value 2: only display parameters modified after power on of the last time (reserved) LED ten's place: monitoring parameters display mode 0: only display main monitoring parameters 1: alternate display of main and auxiliary parameters (interval time 1S) LED hundred's place and thousand's place: reserved	0000	○
F7.12	Parameter initialization	0: disabled 1: restore to factory defaults (all user parameters)	0	×

Function Code	Name	Set Range	Factory Default	Modification
		except motor parameters) 2: restore to factory defaults (all user parameters) 3: clear fault record		
F7.13	Write-protect	0: allow all parameters to be modified (some are not during operation) 1: only allow F0.06, F0.7 and F0.14 to be modified 2: only allow F7.14 to be modify	0	○
F7.14	Parameter copy function	0: disabled parameters upload to operation panel 2: all function code parameters download to the driver 3: download all function code parameters except motor parameters to the driver Note1: when selecting parameters to download, the software will check if it is in accordance with the driver power specification; if not, all the parameters relevant to model will not be changed. Note2: only keyboard KB2 has copy function, copy with normal keyboard will increase fault.	0	×
F7.15	LCD language option (only for LCD panel)	0: Chinese 1: English 2: reserved	0	○
F8 Group - Auxiliary function				
F8.00	Acc time 2			○
F8.01	Dec time 2			○
F8.02	Acc time 3			○
F8.03	Dec time 3			○
F8.04	Acc time 4			○
F8.05	Dec time 4			○
F8.06	Acc/Dec time unit	0: second 1: minute 2: 0.1s	0	○
F8.07	Frequency setting of forward jog operation	0.00~ 【F0.11】 upper limit frequency	5.00	○
F8.08	Frequency setting of reverse jog operation	0.00~ 【F0.11】 upper limit frequency	5.00	○
F8.09	Jog Acc time	0.1 ~ 3600.0S 0.4 ~ 4.0KW 7.5S 5.5 ~ 30.0KW 15.0S 37.0 ~ 132.0KW 40.0S 160.0~ 630.0KW 60.0S		○
F8.10	Jog Dec time			○
F8.11	Jog interval time	0.0~100.0s	0.1	○
F8.12	Hopping freq.1	0.00~upper limit frequency	0.00	○
F8.13	Hopping freq.1 range	0.00~upper limit frequency	0.00	○
F8.14	Hopping freq.2	0.00~upper limit frequency	0.00	○
F8.15	Hopping freq.2 range	0.00~upper limit frequency	0.00	○
F8.16	Hopping freq.3	0.00~upper limit frequency	0.00	○
F8.17	Hopping freq.3 range	0.00~upper limit frequency	0.00	○

Function Code	Name	Set Range	Factory Default	Modification
F8.18	Action when set freq.is lower than lower limit freq.	0: run at lower limit freq. 1: run at zero freq. after delay time (start without delay) 2: stop after delay time (start without delay)	0	×
F8.19	Delay time of stopping when freq. is lower than limit (simple sleep)	0.0~3600.0s	10.0	○
F8.20	Zero freq. brake current	0.0~150.0%* rated current of motor	0.0	×
F8.21	FWD/REV transition time	0.0~100.0s	0.0	○
F8.22	FWD/REV switch mode	0: over zero freq. switch 1: over start freq. switch	0	×
F8.23	Standby deceleration time when emergency brake	0.1~3600.0s	1.0	○
F8.24	Stopping current, direct current, braking current, maintaining time	0.0~100.0s	0.0	○
F8.25	Freq. arrival detectionrange (FAR)	0.0~100.0%* 【F0.10】 pper limit freq.	10.0%	○
F8.26	FDT1 detection method	0: speed set value 1: speed detected value	0	○
F8.27	FDT1 level	0.00Hz~ 【F0.11】 pper limit freq.	50.00	○
F8.28	FDT1 lag	0.0~100.0%* 【F8.27】	2.0%	○
F8.29	FDT2 detection method	0: speed set value 1: speed detected value	0	○
F8.30	FDT2 level	0.00Hz~ 【F0.11】 pper limit freq.	25.00	○
F8.31	FDT2 Lag value	0.0~100.0%* 【F8.30】	4.0%	○
F9 Group – Protective Parameters				
F9.00	Motor overload protection	0: disabled 1: common motor (electronic heat relay, with low speed compensation) 2: variable frequency motor (electronic heat relay, without low speed compensation)	1	×
F9.01	Motor overload protection factor	20.0%~120.0%	100.0%	×
F9.02	Undervoltage protection	0: disabled 1: enabled (undervoltage is seen as fault)	0	×
F9.03	Undervoltage protection level	220V: 180~280V 200V 380V: 330~480V 350V		×
F9.04	Overvoltage limit level	220V: 350~390V 370V 380V: 600~780V 660V		×
F9.05	Voltage limit factor in decelerating	0~100 0: protection invalid of stall over voltage		×
F9.06	Current limiting threshold (only valid for VF mode)	G type: 80%~200%*VFD rated current 160% P type: 80%~200%*VFD rated current 120%		×

Function Code	Name	Set Range	Factory Default	Modification
F9.07	Current limiting in the field weakening region	0: limited by F9.06 1: limited by conversion value of F9.06	0	×
F9.08	Current limiting factor in accelerating	0~100 0: acceleration current limiting is disabled		×
F9.09	Current limiting in constant speed running	0: disabled 1: enabled	1	×
F9.10	Off load detection time	0.1S~60.0S	5.0	○
F9.11	Off load detection level	0~100%*VFD rated current 0: off load detection is disabled	0%	○
F9.12	Overload pre-alarm level	G type: 20%~200%*VFD rated current 160% P type: 20%~200%*VFD rated current 120%		○
F9.13	Overload	0.0~30.0s	10.0	○
F9.14	Temperature detection threshold	0.0℃~90.0℃	65.0℃	×
F9.15	Phase loss protection of input and output	0: disabled 1: disabled for input, enabled for output 2: enabled for input, disabled for output 3: enabled		×
F9.16	Phase loss protection of input and output	0: disabled 1: disabled for input, enabled for output 2: enabled for input, disabled for output 3: enabled	1.0	○
F9.17	Delay time of input phase loss protection	0.0~30.0s	50%	×
F9.18	Detection reference of output phase loss protection	0%~100%*VFD rated current	1.00	×
F9.19	Detection factor of output current imbalance	1.00~10.00 1.00: imbalance detection is disabled Note: detection of output current imbalance and output phase loss share the same reference parameter FA.17 and fault code E-13.	0	◆
F9.20	reserved	—	0	×
F9.21	Feedback disconnection detection value	0.0~100.0%	0.0%	○
F9.22	Feedback disconnection detection time	0.0~3600.0S	10.0	○
F9.23	reserved	—	0	◆
F9.24	Action of RS485 communication error	0: protection action and coast to stop 1: alarm and maintain the current operation 2: alarm and stop according to the preset mode	1	×

Function Code	Name	Set Range	Factory Default	Modification
F9.25	RS485 communication timeout detect	0.0: no detect 0.1~100.0s note: communication time out detection is disabled in stop status	5.0	○
F9.26	Action of operation panel communication error	0: protection action and coast to stop 1: alarm and maintain the current operation 2: protection action and stop according to the preset stop mode	1	×
F9.27	Operation panel communication timeout detect	0.0~100.0s	1.0	○
F9.28	Action of EEPROM read-write error	0: protection action and coast to stop 1: alarm and maintain the current operation	0	×
F9.29-F9.35	reserved	—	0	◆
FA Group – PID Control Parameters				
FA.00	PID operation input mode	0: auto 1: manually input via defined multi-function terminal	0	×
FA.01	PID input channel	0: digital setting 1: AI1 2: AI2 3: pulse setting 4: RS485 communication	0	○
FA.02	Digital reference input setting	0.0~100.0%	50.0%	○
FA.03	PID feedback channel	0: AI1 1: AI2 2: AI1+AI2 3: AI1-AI2 4: MAX {AI1, AI2} 5: MIN {AI1, AI2} 6: pulse setting 7: RS485 communication	0	○
FA.04	PID controller advanced setting	LED one's place: PID sign 0: positive 1: negative LED ten's place: proportion regulation (reserved) 0:integral regulation of constant proportion 1: integral regulation of auto changing proportion LED hundred's place: integral regulation 0: stop integral regulation when the frequency reaches the upper or lower limits 1: continue the integral regulation when the frequency reaches the upper or lower limits LED thousand's place: reserved	000	×
FA.05	Proportional gain KP1	0.01~100.00	5.00	○
FA.06	Integral time Ti1	0.01~10.00s	0.05	○
FA.07	Derivative time Td1	0.01~10.00s 0.0: no derivation	0.00	○
FA.08	Sampling cycle T	0.01~10.00s	0.10	○

Function Code	Name	Set Range	Factory Default	Modification
		0.00: auto		
FA.09	Error limit	0.0~100.0%	0.0%	○
FA.10	Close-loop preset freq.	0.00~upper limit freq.	0.00	○
FA.11	Preset freq. hold time	0.0~3600.0s	0.0	×
FA.12	Sleep mode	0: disabled 1: sleep when feedback pressure exceeding or lower than sleep threshold 2: sleep when feedback pressure and output frequency are stable	1	×
FA.13	Stop method of sleep mode	0: decelerate to stop 1: coast to stop	0	○
FA.14	Deviation limit of feedback when entering sleep state compared with set pressure	0.0~20.0% Note: this parameter is only valid to the second sleep mode.	0.5%	○
FA.15	Threshold value of sleeping	0.0~200.0% Note: this threshold value is the percentage of given pressure, and it is only valid for the first sleep mode.	100.0%	○
FA.16	Threshold value of awaking	0.0~200.0% Note: this threshold value is the percentage of given pressure.	90.0%	○
FA.17	Delay time of sleep	0.0~3600.0s	100.0	○
FA.18	Delay time of awaking	0.0~3600.0s	5.0	○
FA.19	Delay time of adding pump	0.0~3600.0s	10.0	○
FA.20	Delay time of reducing pump	0.0~3600.0s	10.0	○
FA.21	Water supply enabling (FA.21-FA.24 not supported by hardware)	0: disabled 1: PFC enabled 2: SPFC enabled	0	×
FA.22	Delay time of terminal disconnect and connect	0.0~6000.0s	0.1	○
FA.23	Polling time	0.0~6000.0h	48.0	○
FA.24	Lower limit freq. of reducing pump	0.0~600.00HZ	35.00	×
FA.25	Sensor range	0.00~60.00 (MPa、Kg)	10.00	○
FA.26	Pressure setting	0.00~【FA.25】 (MPa、Kg)	5.00	○
FA.27	Main pump startup delay	0.0~3600.0s	0.3	○
FA.28	Auxiliary pump start - up mode selection	0: Direct opening, 1: Soft - start	0	×
FA.29	Proportional gain KP2	0.01~100.00	1.00	○
FA.30	Integral time Ti2	0.01~10.00s	0.10	○
FA.31	Derivative time Td2	0.01~10.00s 0.0: no derivation	0.00	○

Function Code	Name	Set Range	Factory Default	Modification
FA.32	Pid upper cut-off frequency	【FA.33】～300.00Hz	50.00	×
FA.33	Lower cut-off frequency of PID	-300.00Hz～【FA.32】	0.00	×
FA.34	Sleep frequency	0.00Hz～【F0.11】	0.00	×
FB Group- Traverse and Fixed Length Control				
FB.00	Traverse control	0: disabled 1: enabled	0	×
FB.01	Input method of traverse mode	0: auto 1: manually input via defined multi-function terminal	0	×
FB.02	Amplitude control	0: fixed amplitude 1: varied amplitude	0	×
FB.03	Restart method of traverse mode	0: start to the state before stop 1: restart without other requirement	0	×
FB.04	Save traverse state upon power failure	0: save 1: not save	0	×
FB.05	Preset traverse freq.	0.00Hz～upper limit Freq.	10.00	○
FB.06	Preset traverse freq. hold time	0.0～3600.0s	0.0	×
FB.07	Traverse amplitude	0.0～100.0%	0.0%	○
FB.08	Step freq.	0.0～50.0% (of amplitude)	0.0%	○
FB.09	Traverse rising time	0.1～3600.0s	5.0	○
FB.10	Traverse falling time	0.1～3600.0s	5.0	○
FB.11	reserved	—	0	◆
FB.12	Length control	0: disabled 1: enabled	0	×
FB.13	Preset length	0.000～65.535(KM)	0.000	○
FB.14	Actual length	0.000～65.535(KM)	0.000	○
FB.15	Length factor	0.100～30.000	1.000	○
FB.16	Length calibration	0.001～1.000	1.000	○
FB.17	Shaft circumference	0.10～100.00CM	10.00	○
FB.18	Pulse per revolution (X7)	1～65535	1024	○
FB.19	Counting value arrival processing	0: stop counting, stop output 1: stop counting, resume output 2: cycle count, stop output 3: cycle count, resume output	3	×
FB.20	Counting start condition	0: always count since power on 1: count in operation status, stop counting in stop status	1	×
FB.21	Counter reset value	【FB.22】～65535	0	○
FB.22	Counter detection value	0～【FB.21】	0	○
FB.23	time out processing	0: stop timing, stop output 1: stop timing, resume output 2: cycle timing, stop output 3: cycle timing, resume output	3	×

Function Code	Name	Set Range	Factory Default	Modification
FB.24	Timing start condition	0: timing starts since power on 1: timing starts in operation status, and stops in stop status	1	×
FB.25	Timing setting	0~65535S	0	○
FC Group – MS and PLC Running				
FC.00	PLC running mode	0: stop after single cycle 1: retain value after single cycle 2: continuous cycle of limited times 3: continuous cycle	0	×
FC.01	Input mode of PLC	0: auto 1: manually input via defined multi-function terminal	0	×
FC.02	PLC running state saving after poweroff	0: not save 1: save the stage and frequency when poweroff	0	×
FC.03	PLC restart mode	0: restart from the first stage 1: start from the stage where the driver stops (fault) 2: start from the stage where the driver stops(fault) at the recorded frequency	0	×
FC.04	Limited times of continuous cycle	1~65535	1	○
FC.05	Unit of PLC running time	0: s 1: m	0	×
FC.06	MS frequency 0	-upper limit Freq.~upper limit Freq.	5.00	○
FC.07	MS frequency 1	-upper limit Freq.~upper limit Freq.	10.00	○
FC.08	MS frequency 2	-upper limit Freq.~upper limit Freq.	15.00	○
FC.09	MS frequency 3	-upper limit Freq.~upper limit Freq.	20.00	○
FC.10	MS frequency 4	-upper limit Freq.~upper limit Freq.	25.00	○
FC.11	MS frequency 5	-upper limit Freq.~upper limit Freq.	30.00	○
FC.12	MS frequency 6	-upper limit Freq.~upper limit Freq.	40.00	○
FC.13	MS frequency 7	-upper limit Freq.~upper limit Freq.	50.00	○
FC.14	MS frequency 8	-upper limit Freq.~upper limit Freq.	0.00	○
FC.15	MS frequency 9	-upper limit Freq.~upper limit Freq.	0.00	○
FC.16	MS frequency 10	-upper limit Freq.~upper limit Freq.	0.00	○
FC.17	MS frequency 11	-upper limit Freq.~upper limit Freq.	0.00	○
FC.18	MS frequency 12	-upper limit Freq.~upper limit Freq.	0.00	○
FC.19	MS frequency 13	-upper limit Freq.~upper limit Freq.	0.00	○
FC.20	MS frequency 14	-upper limit Freq.~upper limit Freq.	0.00	○
FC.21	MS frequency 15	-upper limit Freq.~upper limit Freq.	0.00	○
FC.22	Acc/Dec time of stage 0	0~3	0	○
FC.23	Run time of segment 0	0.0~6553.5S(M)	0.0	○
FC.24	Acc/Dec time of stage 1	0~3	0	○
FC.25	Run time of segment 1	0.0~6553.5S(M)	0.0	○

Function Code	Name	Set Range	Factory Default	Modification
FC.26	Acc/Dec time of stage 2	0~3	0	○
FC.27	Run time of segment 2	0.0~6553.5S(M)	0.0	○
FC.28	Acc/Dec time of stage 3	0~3	0	○
FC.29	Run time of segment 3	0.0~6553.5S(M)	0.0	○
FC.30	Acc/Dec time of stage 4	0~3	0	○
FC.31	Run time of segment 4	0.0~6553.5S(M)	0.0	○
FC.32	Acc/Dec time of stage 5	0~3	0	○
FC.33	Run time of segment 5	0.0~6553.5S(M)	0.0	○
FC.34	Acc/Dec time of stage 6	0~3	0	○
FC.35	Run time of segment 6	0.0~6553.5S(M)	0.0	○
FC.36	Acc/Dec time of stage 7	0~3	0	○
FC.37	Run time of segment 7	0.0~6553.5S(M)	0.0	○
FC.38	Acc/Dec time of stage 8	0~3	0	○
FC.39	Run time of segment 8	0.0~6553.5S(M)	0.0	○
FC.40	Acc/Dec time of stage 9	0~3	0	○
FC.41	Run time of segment 9	0.0~6553.5S(M)	0.0	○
FC.42	Acc/Dec time of stage 10	0~3	0	○
FC.43	Run time of segment 10	0.0~6553.5S(M)	0.0	○
FC.44	Acc/Dec time of stage 11	0~3	0	○
FC.45	Run time of segment 11	0.0~6553.5S(M)	0.0	○
FC.46	Acc/Dec time of stage 12	0~3	0	○
FC.47	Run time of segment 12	0.0~6553.5S(M)	0.0	○
FC.48	Acc/Dec time of stage 13	0~3	0	○
FC.49	Run time of segment 13	0.0~6553.5S(M)	0.0	○
FC.50	Acc/Dec time of stage 14	0~3	0	○
FC.51	Run time of segment 14	0.0~6553.5S(M)	0.0	○
FC.52	Acc/Dec time of stage 15	0~3	0	○
FC.53	Run time of segment 15	0.0~6553.5S(M)	0.0	○
FC.54	Reserved	—	0	◆
Fd Group - RS485 Communication Parameters				
Fd.00	Protocol	0: MODBUS 1: user-defined	0	×
Fd.01	Local address	0 broadcast address 1~247: slave	1	×
Fd.02	Baud rate setting	0: 2400BPS 1: 4800BPS 2: 9600BPS 3: 19200BPS 4: 38400BPS 5: 115200BPS	3	×
Fd.03		0: no parity (N, 8, 1) for RTU	0	×

Function Code	Name	Set Range	Factory Default	Modification
	Data format	1: even parity (E, 8, 1) for RTU 2: odd parity (O, 8, 1) for RTU 3: no parity (N, 8, 2) for RTU 4: even parity (E, 8, 2) for RTU 5: odd parity (O, 8, 2) for RTU ASCII mode is reserved at present		
Fd.04	Response delay	0~200ms	5	×
Fd.05	Transmission response	0: response for write operation 1: no response for write operation	0	×
Fd.06	Ratio correlation coefficient	0.01~10.00	1.00	○
Fd.07	Communication mode selection	0: Universal mode, 1: MD380 mode	0	×
FEGroup – Advanced Function and Performance Parameters				
FE.00	Dynamic braking	0: disabled 1: always enabled 2: only enabled when decelerating	1	×
FE.01	Initial voltage of dynamic braking	220V: 340~380V 360V 380V: 660~760V 680V		○
FE.02	Hysteresis voltage of dynamic braking	220V: 10~100V 5V 380V: 10~100V 10V		○
FE.03	Action ratio of dynamic braking	10~100%	100%	○
FE.04	Restart after power failure	0: disabled 1: start at start frequency 2: start in speed tracking mode	0	×
FE.05	Restart delay after power failure	0.0~60.0s	5.0	×
FE.06	Auto reset times	0~100 the setting value of 100 means unlimited times	0	×
FE.07	Auto reset interval	0.1~60.0s	3.0	×
FE.08	Cooling fan control	0: auto control mode 1: always running when power on	0	○
FE.09	Password of operation limiting function	0~65535 Note 1: the password will take into effect 3 minutes later after set successfully Note 2: this parameter cannot be initialized.	0	○
FE.10	Operation limiting function	0: disabled 1: enabled Note: this parameter cannot be initialized	0	○
FE.11	Limiting time	0~65535(h) Note: this parameter cannot be initialized	0	×
FE.12	Freq. decreasing point of instantaneous power failure	220V:180~330V 250V 380V:300~550V 450V		×
FE.13	Freq. decreasing factor of instantaneous power	0: the function of immunity to transient power failure is disabled	0	○

Function Code	Name	Set Range	Factory Default	Modification
	failure	1~100		
FE.14	Droop control	0.00~10.00Hz 0.00: droop control function is disabled	0.00	×
FE.15	Delay time of rotating speed tracking	0.1~5.0S	1.0	×
FE.16	Current amplitude limiting of rotating speed tracking	80%~200%*VFD rated current	100%	×
FE.17	Speed of rotating speed tracking	1~125	25	×
FE.18	PWM mode	LED one's place: PWM synthesize method 0: seven segments of full band 1: switch from 7 segment to five segments LED ten's place: PWM temperature correlation 0: disabled 1: enabled LED hundred's place: PWM frequency correlation 0: disabled 1: low freq. adjustment, high Freq. adjustment 2: no adjustment for low freq., high freq. adjustment 3: low freq. adjustment, no adjustment for high freq. LED thousand's place: flexible PWM function 0: disabled 1: enabled	0001	×
FE.19	AVR function	LED one's place: AVR function 0: disabled 1: always enabled 2: only disabled when decelerating LED ten's place: overmodulation 0: disabled 1: enabled LED hundred's place: dead-time compensation 0: disabled 1: enabled LED thousand's place: harmonic components optimizing (reserved) 0: disabled 1: enabled	1102	×
FE.20	Oscillation suppressing initial freq.	0.00~300.00Hz		○
FE.21	Flux braking	0~100 0: disabled	0	○
FE.22	Energy saving control factor	0~100 0: disabled	0	○
FE.23	MS priority	0: disabled 1: MS prior to F0.03 setting	0	×
FE.24	Jog priority	0: disabled 1: the jog has the highest priority during the driver operation	0	×
FE.25	Special function	LED one's place: A02 and D0 output selection 0: A02 enabled 1: D0 enabled LED ten's place: OC function (reserved) 0: disabled 1: enabled LED hundred's place: OU1 function (reserved) 0: disabled 1: enabled LED thousand's place: reserved	010	×

Function Code	Name	Set Range	Factory Default	Modification
FE.26	Oscillation suppression upper limit freq.	0.00~300.00Hz	50.00	○
FE.27	Oscillation suppression coefficient	1~500	50	○
FE.28	Oscillation suppression voltage	0.0~25.0%* Motor rated voltage	5.0	○
FE.29	Password of operation limiting function	0~65535 Note 1: the password will take into effect 3 minutes later after set successfully Note 2: this parameter cannot be initialized.	0	○
FE.30	Control software version	1.00~99.99	1.01	◆
FE.31	Keypad software version	1.00~99.99	1.00	◆
FE.32	VFD rated power	0.4~999.9KW (G/P)		◆
FFGroup- Manufacturer parameters				
FF.00	Manufacturer password	0~65535 Note: the password is successful and it will take 3 minutes to enter into force.	0	○
FF.01	Reserved	—	0	◇
FF.02	Converter model	0~30 0 0.4KW 1 0.75KW 2 1.5KW 3 2.2KW 4 4.0KW 5 5.5KW 6 7.5KW 7 11KW 8 15KW 9 18.5KW 10 22KW 11 30KW 12 37KW 13 45KW 14 55KW 15 75KW 16 90KW 17 110KW 18 132KW 19 160KW 20 185KW 21 200KW 22 220KW 23 250KW 24 280KW 25 315KW 26 350KW 27 375KW		◇
FF.03	Rated power of frequency converter	0.4~999.9KW Note: this parameter can only be viewed		◇
FF.04	Rated voltage of frequency converter	0~999V	380	◇
FF.05	Rated current of frequency converter	0.1~6553.5A		◇
FF.06	Dead time	3.2~10.0μS 0.4~4.0KW 3.2μS 5.5~22KW 3.5μS 30~110KW 4.0μS 132~630KW 4.5μS		◇
FF.07	Software overvoltage point	220V:0~450V 400V 380V:0~850V 800V		◇
FF.08	Software under voltage point	220V:0~280V 180V 380V:0~440V 320V		◇
FF.09	Software overcurrent point	50.0~250.0%	220.0%	◇
FF.10	Voltage correction factor	80.0~120.0%	100.0%	◇
FF.11	Current correction factor	50.0~150.0%	100.0%	◇
FF.12	Temperature detection method	0: I 1: II	1	◇
FF.13	First, the temperature sensor protectionthreshold	50.0℃~100.0℃	85.0	◇
FF.14	Second, the temperature sensor protectionthreshold	50.0℃~100.0℃	85.0	◇

Function Code	Name	Set Range	Factory Default	Modification
FF.15	Clearing function of information	0: disabled 1: Clearing the cumulative elapsed time 2: Clearing the cumulative power - on time 3: Clear the fan accumulation run time 4: Removal of accumulated electricity consumption	0	◇
FF.16	Machine - factory bar code 1	0~65535	0	◇
FF.17	Machine - factory bar code 2	0~65535	0	◇
FF.18	Machine factory date (month, day)	0~1231	0	◇
FF.19	Machine date (year)	2010~2100	2013	◇
FF.20	Software upgrade date (month, day)	0~1231	0622	◇
FF.21	Date of software upgrade (year)	2010~2100	2017	◇
FF.22	Special function selection	LED ones digit: frequency converter prohibits G/P type 0: invalid, 1: valid LED Tens digit current direction selection 0: forward (pointing to motor), 1: reverse (point to frequency converter) LED hundred digit: power selection for the system 0: 5V , 1: 3.3V LED Thousands digit: reservation 0: Reserved 1: Reserved	110	◇
d Group - Monitoring Parameter Group and Fault Record				
d-00	Output Frequency	0.00 ~ maximum output frequency 【F0.10】	0	◆
d-01	Set Frequency	0.00 ~ maximum output frequency 【F0.10】	0	◆
d-02	EstimatedMotor Frequency	0.00 ~ maximum output frequency 【F0.10】 Note:motor runningfrequency converted from estimated motor speed	0	◆
d-03	Main Set Frequency	0.00 ~ maximum output frequency 【F0.10】	0	◆
d-04	Auxiliary Set Frequency	0.00 ~ maximum output frequency 【F0.10】	0	◆
d-05	Output Current	0.0~6553.5A	0	◆
d-06	Output Voltage	0~999V	0	◆
d-07	Output Torque	-200.0~+200.0%	0	◆
d-08	Motor Revolving Speed (RPM/min)	0~36000 (RPM/min)	0	◆
d-09	Motor Power Factor	0.00~1.00	0	◆
d-10	Run Linear Velocity (m/s)	0.01~655.35(m/s)	0	◆
d-11	Set Linear Velocity (m/s)	0.01~655.35(m/s)	0	◆
d-12	Bus voltage (V)	0~999V	0	◆
d-13	Input Voltage (V)	0~999V	0	◆
d-14	PID Set Value (V)	0.00~10.00V	0	◆
d-15	PID Feedback (V)	0.00~10.00V	0	◆
d-16	Analog Input AII(V/mA)	0.00~10.00V	0	◆

Function Code	Name	Set Range	Factory Default	Modification
d-17	Analog Input AI2(V)	0.00~10.00V	0	◆
d-18	Impulse Frequency Input (KHz)	0.00~50.00kHz	0	◆
d-19	Analog Output AO1(V/mA)	0.00~10.00V	0	◆
d-20	Analog Output AO2(V)	0.00~10.00V	0	◆
d-21	Input Terminal Status	0~FFH Note: the sequence from high to low order digit in binary system X8/X7/X6/X5/X4/X3/X2/X1	0	◆
d-22	Output Terminal Status	0~FH Note: the sequence from high to low order digit in binary system R2/R1/Y2/Y1	0	◆
d-23	VFD Running Status	0~FFFFH BIT0: run/stop BIT1: reverse/forward BIT2: zero-speed running BIT3: reserved BIT4: accelerating BIT5: decelerating BIT6: constant speed running BIT7: pre-excitation BIT8: tuning of VFD parameter BIT9: overcurrent limit BIT10: overvoltage limit BIT11: amplitude limiting of torque BIT12: amplitude limiting of speed BIT13: speed control BIT14: torque control BIT15: reserved	0	◆
d-24	Current stage of multistage speed	0~15	0	◆
d-25	reserved	0~5000Hz	0	◆
d-26	reserved	—	0	◆
d-27	Current count value	0~65535	0	◆
d-28	Set count value	0~65535	0	◆
d-29	Current timing value(S)	0~65535S	0	◆
d-30	Set timing value(S)	0~65535S	0	◆
d-31	Current length	0.000~65.535(KM)	0	◆
d-32	Set length	0.000~65.535(KM)	0	◆
d-33	Radiator Temperature 1	0.0℃~+110.0℃	0	◆
d-34	Radiator Temperature 2	0.0℃~+110.0℃	0	◆
d-35	accumulative run time of VFD (hour)	0~65535H	0	◆
d-36	accumulative power-on time of VFD (hour)	0~65535H	0	◆
d-37	accumulative run time of fan (hour)	0~65535H	0	◆
d-38	Accumulative electricity	0~9999KWH	0	◆

Function Code	Name	Set Range	Factory Default	Modification
	consumption (low order digit)			
d-39	Accumulative electricity consumption (high order digit)	0~9999KWH (*10000)	0	◆
d-40	Special model monitoring parameter (reserved)	0.00~60.00 (MPa, Kg)	0.00	◆
d-41	Special model monitoring	0.0~6553.5KW	0.0	◆
d-42	Special model monitoring parameter (reserved)	—	0	◆
d-43	Special model monitoring parameter (reserved)	—	0	◆
d-44	Special model monitoring parameter (reserved)	—	0	◆
d-45	Special model monitoring parameter (reserved)	—	0	◆
d-46	Special model monitoring parameter (reserved)	—	0	◆
d-47	Special model monitoring parameter (reserved)	—	0	◆
d-48	The third to last fault type	0~27	0	◆
d-49		0~27	0	◆
d-50	Last fault type	0~27	0	◆
d-51	Current fault type	0~27	0	◆
d-52	Run frequency of current fault	0.00~【F0.11】 upper limit of frequency	0	◆
d-53	Output current of current fault	0.0~6553.5A	0	◆
d-54	Busbar voltage of current fault	0~999V	0	◆
d-55	Input terminal status of current fault	0~7FH Note: sequence from high to low order digit in binary system X7/X6/X5/X4/X3/X2/X1	0	◆
d-56	Output terminal status of current fault	0~FH Note:sequence from high to low order digit in binary system R1/Y2/Y1	0	◆
d-57	Run state of current fault	0~FFFFH	0	◆

6.Detailed explanation of parameters

F0 Group - Basic Run Parameters

F0.00	VFD type	
	0~1	0

0:G type (constant torque load type)

1: P type (fan and water pump load type)

For our VFD products, G/P type are combined, i.e. G type inverter can be used as P type inverter with power of one grade higher, but only if the function code is set with corresponding value.

F0.01	Control mode	
	0~4	Depending on model

0: common V/F control

This control mode is used when there is a need to drive one more motors with a single inverter and there is no access to the parameters of controlled motor. This control mode is most commonly used and applied in any circumstance where no strict requirement is needed for the motor control performance.

1: advanced V/F control

This control mode introduced flux closed loop control idea, and achieved a large improvement of torque response of motor control in full frequency range, torque output ability in low frequency, without the sensitivity to motor parameter as field-oriented vector control. It is especially suitable to situation where there is certain requirements for starting torque (like drawbench, ball mill, etc.).

2: open loop current vector control (sensitive to motor parameter)

As a real current vector control mode, it has both high torque output performance as flux control mode and flexible torque output. But considering its sensitivity to motor parameter, the operator had better activate the dynamic self-learning of motor parameters for a better effect.

3: reserved

4: separation type V/F control

With this control mode, the output voltage and frequency of VFD can both be controlled individually, not according a constant V/F relation. It can be used in areas like variable-frequency power source and EPS.

Note: factory default is 0 for above 55KW, and 1 for under 55KW.

F0.02	Operation command channel	
	0~2	0

This function code is used for choosing the physical channel for receiving operation commands like run and stop.

0: keypad run command channel Controlled with keys in keypad like RUN,STOP/RESET,M-FUNC

1: terminal run command channel Controlled by multi-function terminals defined as FWD, REV, JOG forward, JOG reverse.

2: communication run command channel Controlled with communication method via upper computer.

!Notice:

Even during running status, the run command channel can be changed by modifying this function code set value. Please set carefully!

F0.03	Main freq. source A	
	0~9	0

0: digital set (▲▼), encoder)

The frequency is originally set as F0.6, but can be adjust with key (▲▼) or encoder. The modified frequency value will be saved to F0.6 after power down (if no need for saving, set the F0.16 as 1).

1: digital set 2 (up/down terminal adjust)

The initial value of frequency is F0.7. The running frequency can be changed by on/off of multi-functional terminal defined as UP/DOWN (for details check F4 group function code of X terminal increase/decrease item). When UP and COM terminal are both closed, frequency increase; when DOWN and COM terminal are both closed, frequency decrease; when UP/COM terminal and COM terminal are both open or closed at the same time, the frequency remains unchanged. If set frequency saving upon power down, the modified frequency value will be

saved to F0.7 after power down. The modifying rate of running frequency by UP/DOWN terminal can be set by function code F4.12

!Notice:

No matter set by key (▲▼) or terminal UP/DOWN, the set value is added with a regulating variable based on F0.6 or F0.7, and the final output frequency ranges from the lower limit to the maximum output value. The regulating variable via terminal UP/DOWN can be cleared by choosing “UP/DOWN terminal frequency zero clearing” via X terminal, and the regulating variable of keypad can be cleared by choosing “clear key (▲▼) set of frequency” via key M-FUNC .

2: digital set 3 (communication set)

Modify the set frequency via serial port frequency set command, for details check FB group communication parameter.

3: AI1 analog set (0~10V/20mA)

The frequency setting is determined by analog voltage/current of AI1 terminal, and the input range DC 0~10V/20mA. The relevant setting is in F4.13~F4.17.

4: AI2 analog set (0~10V)

Frequency setting is determined by analog voltage/current of AI2 terminal, input ranges DC 0~10V. The relevant setting is in F4.18~F4.22.

5: impulse set

Frequency setting is determine by terminal impulse frequency (only input via X6, see F4.05). Input impulse signal specification: high level range 15~30V; frequency range 0~50kHz. The relevant setting is in F4.23~F4.27.

6: multispeed running setting

The VFD runs in multispeed mode in this frequency setting mode. Set the F4 group “X terminal as multispeed” and F9 group “multispeed frequency” function code to determine the correspondence of specified section number and frequency.

7: simple PLC set

It needs to set function code FC.00~FC.05 to select this mode. Function code FC.06~FC.21 are used to determine the running frequency of each PLC section, and FC.22~FC.53 are used to the increase/decrease time and running time of each section.

8: PID control setting

The VFD runs in process PID control mode in this frequency setting mode. Function codes of F8 group are needed to be set such as “process PID parameter”, analog given and impulse given. The running frequency of VFD is the value after PID taking effect. For details check F8 group function description.

9: panel potentiometer setting

Operate the potentiometer on keyboard to adjust running frequency, and regulating range is 0~max. output frequency.

F0.04	Auxiliary freq. source B	
	0~9 (principle freq. channel selection)	3

0: digital set 1(keypad (▲▼), encoder)

1: digital set 2 (UP/DOWN terminal adjustment)

2: AI1 analog set (0~10V/20mA)

3: AI2 analog set (0~10V)

4: panel potentiometer setting

5: impulse set (0~50KHZ)

6: multispeed running setting

7: simple P L C setting

8: PID control setting

9: digital set 3 (communication setting)

Auxiliary frequency specified channel has the same meaning of each item as principle frequency channel, for details check F0.03 description.

F0.05	frequency source combinational algorithm	
	0~8	0

0: principle frequency source A

1: $A+K*B$

Principle frequency A, auxiliary frequency B multiplied by weight coefficient K, the sum of the above two values are the final specified value of VFD frequency.

2: $A-K*B$

Principle frequency A minus auxiliary frequency B multiplied by weight coefficient K, the result is the final specified value of VFD frequency.

3: $|A-K*B|$

Principle frequency A, auxiliary frequency B multiplied by weight coefficient K, the absolute value of their difference is the final specified value of VFD frequency.

4: $MAX(A, K*B)$

Principle frequency A, auxiliary frequency B multiplied by weight coefficient K, the higher value of these two is the final specified value of VFD frequency.

5: $MIN(A, K*B)$

Principle frequency A, auxiliary frequency B multiplied by weight coefficient K, the lower value of these two is the final specified value of VFD frequency.

6: switch from A to $K*B$

This function is used together with number 29 item of F4 group parameter X1~X8. When F0.05=6, and X terminal function is 29, the X terminal is valid, frequency given source switch from A to $K*B$; if X terminal is invalid, the frequency source returns to A.

7: switch between A and $(A+K*B)$

This function is used together with number 30 item of F4 group parameter X1~X8. When F0.05=7, and X terminal function is 30, the X terminal is valid, frequency given source switch from A to $(A+K*B)$; if X terminal is invalid, the frequency source returns to A.

8: switch between A and $(A-K*B)$

This function is used together with number 31 item of F4 group parameter X1~X8. When F0.05=8, and X terminal is 31, X terminal is valid, frequency given source switch from A to $(A-K*B)$; if X terminal is invalid, the frequency source returns to A.

!Notice:

The given value of frequency is still restricted by start frequency and higher and lower limit frequency, and being positive or negative determines the running direction of VFD.

K is the weight coefficient of auxiliary frequency, for details check F0.08 function code description.

F0.06	Frequency source digital setting 1	
	0.00Hz~ 【F0.11】 upper limit frequency	50.00

When frequency channel is defined as digital given 1 (principle and auxiliary frequency source are both 0), this function parameter is initial setting frequency given by keypad digital frequency.

F0.07	Frequency source digital setting 2	
	0.00Hz~ 【F0.11】 upper limit frequency	50.00

When frequency channel is defined as digital given 2 (principle and auxiliary frequency source are both 1), this function parameter is initial setting frequency given by VFD terminal.

F0.08	Auxiliary frequency source weight coefficient K setting	
	0.01~10.00	1.00

K is the weight coefficient of auxiliary frequency source, valid when F0.05 is 1~8.

F0.09	Running direction	
	0~2	0

0: forward run

In this mode, the actual output phase sequence is the same with system default. Key for forward control.

1: reverse run

In this mode, the actual output phase sequence is opposite to the system default. Key for reverse control.

2: reverse run forbidden

F0.10	Max. Output Freq.	
	Low freq. stage:MAX{50.00, 【F0.16】}~ 300.00 high freq. stage:MAX{50.0, 【F0.16】}~ 3000.0	50.00
F0.11	Upper limit freq.	
	【F0.17】 ~ 【F0.15】	50.00
F0.12	Lower limit freq.	
	0.00Hz~ 【F0.16】	0.00

The maximum output frequency is highest allowed frequency for output, and the reference of acc./dec. time setting, as f_{max} showed in the following figure; basic running frequency is the minimum frequency when output highest voltage, usually the rated frequency of motor, as f_b showed in the following figure; the maximum output voltage V_{max} is the output voltage when output basic running frequency, usually rated voltage of the motor, as V_{max} showed in the following figure; f_H , f_L are defined as upper limit frequency and lower limit frequency separately, as showed in figure F0-1:

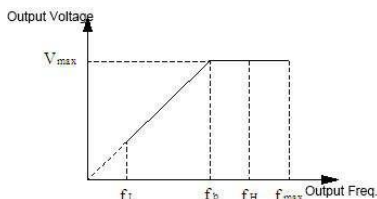

Figure F0-1 Voltage and Frequency

!Notice:

1. The maximum output frequency, upper limit frequency and lower limit frequency should be set cautiously according to nameplate parameter and running condition of controlled motor, or there would be damage to the equipment.
2. Upper limit frequency has valid restriction is to jog running, while lower limit frequency has no restriction to jog running.
3. Apart from upper limit frequency and lower limit frequency, the output frequency of running VFD is also restricted by parameters like start frequency, stop DC braking start frequency, hopping frequency.
4. The maximum output frequency, upper limit frequency and lower limit frequency have relations as showed in figure F0-1, please notice the numerical value order when setting.
5. Upper limit and lower limit of frequency are used to restrict actual output frequency value of motor. If the set value is higher than upper limit, it runs in upper limit frequency; if the set value is lower than the lower limit, it runs in lower limit frequency (the running condition when set frequency lower than lower limit is also relevant to function code F8.18 setting); if set frequency is lower than start frequency, it starts in zero frequency.

F0.13	Carrier frequency setting	
	1.0~16.0KHz	Depending on model
0.4~4.0KW	6.0KHz	1.0~16.0KHz
5.5~30KW	4.5KHz	1.0~16.0KHz
37~132KW	3.0KHz	1.0~10.0KHz
160~630KW	1.8KHz	1.0~5.0 KHz

This function code is used to set carrier frequency of PWM wave from VFD output. Carrier frequency will affect the noise when motor running, raise the carrier frequency properly when there is demand for quiet running. Meanwhile, raising the carrier frequency will increase heat production and electromagnetic interference from the VFD.

When carrier frequency exceeds factory default value, the VFD needs to be used with derating. Normally 5% derating of VFD current for every 1kHz increasing of carrier frequency.

Notice:

- 1: Select different carrier frequency method via function code F0.13

F0.14	Accelerating time 1	
	0.1~3600.0S	Depending on model
F0.15	Decelerating time 1	
	0.1~3600.0S	Depend on model

Accelerating time is the time for VFD to accelerate from zero frequency to the maximum output frequency, Decelerating time is the time for VFD to decelerate from maximum output frequency to zero frequency. There are 4 groups of acc./dec. time parameters for CR600 series VFD, the other 3 groups are defined in function code F8.00~F8.05. The factory default of acc./dec. time is determined by VFD type. For other time groups, please choose by multi-function terminal (refer to F4.00~F4.06 function code). Acc./Dec. time of jogging run is defined in F8.09 and F8.10.

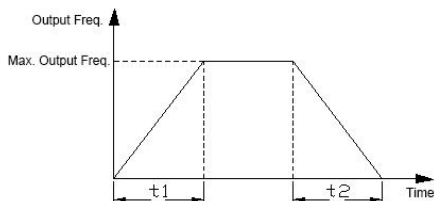

Figure F0-2 Accelerating and Decelerating time

F0.16	Digital freq. set 1 control	
	000~111	000

LED units digit: power down save

0: save

Once power on, the keypad and terminal frequency increment will be initialized to the value saved in EEPROM when power down last time.

1: not save

Once power on, the keypad and terminal frequency increment will be initialized to 0. LED tens digit: keep when stop.

0: keep when stop

When the VFD stops running, the frequency set value stays the last modified value.

1: not keep

When the VFD stops running, the set frequency returns to F0.6.

LED hundreds digit: (▲▼) UP/DOWN frequency adjustment

0: invalid, 1: valid

When valid, operating with key (▲▼), terminal UP/DOWN can achieve the positive or negative adjustment of the frequency.

F0.17	Digital frequency set 2 control	
	000~111	000

LED units digit: power down save .

0: save

Once power on, the keypad and terminal frequency increment will be initialized to the value saved in EEPROM when power down last time.

1: not save

Once power on, the keypad and terminal frequency increment will be initialized to 0.

LED tens digit: keep when stop.

0: keep when stop

When the VFD stops running, the frequency set value stays the last modified value.

1: not keep

When the VFD stops running, the set frequency returns to F0.6.

LED hundreds digit: (▲▼) UP/DOWN frequency adjustment.

0: invalid, 1: valid

When valid, operating with key (▲▼), terminal UP/DOWN can achieve the positive or negative adjustment of the frequency.

F0.18	Frequency output mode	
	0000~0011	0000

0: low frequency mode (0.00~300.00Hz)

1: high frequency mode (0.0~3000.0Hz)

High frequency mode is only valid for V/F control.

F1 Group - Motor Parameters

F1.00	motor type	
	0~1	0

0: AC asynchronous motor

1: PMSM (permanent magnet synchronous motor) (reserved) Asynchronous motor only accepts closed loop vector control at present.

F1.01	Motor's rated power	
	0.4~999.9KW	Depending on model
F1.02	Motor's rated frequency	
	0.01Hz~【F0.10】 max. output freq.	50.00
F1.03	Motor's rated speed	
	0~60000RPM	Depending on model
F1.04	Motor's rated voltage	
	0~999V	Depending on model
F1.05	Motor's rated current	
	0.1~6553.5A	Depending on model

Notice:

These above function codes must be set according to motor nameplate parameter. And please deploy the corresponding motor according the the VFD power, or the control performance of VFD will decrease if the motor power differs too much from VFD power.

F1.06	Stator resistance of asynchronous motor	
	0.001~20.000Ω	Depending on model
F1.07	Rotor resistance of asynchronous motor	
	0.001~20.000Ω	Depending on model
F1.08	Stator/rotor inductance of asynchronous motor	
	0.1~6553.5mH	Depending on model
F1.09	Stator/rotor mutual inductance of asynchronous motor	
	0.1~6553.5mH	Depending on model
F1.10	No-load current of asynchronous motor	
	0.01~655.35A	Depending on model

These above motor parameters have specific implications as showed in figure F1-1.

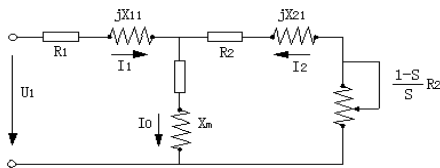

Fig. F1-1 Steady State Equivalent Circuit of Asynchronous Motor

Fig. F1-1 parameters R1, X11, R2, X21, Xm, I0 represent stator resistance, stator leakage inductive reactance, mutual inductive reactance, no-load current.

If there is tuning for the motor, the set value of F1.06~F1.10 will be updated after tuning.

After modifying the rated power F1.01 of asynchronous motor, F1.03~F1.10 parameters will be updated with default parameters of asynchronous motor with corresponding power (F1.02 is rated frequency of motor, not included in the default parameter range of asynchronous motor, and need to be set according to nameplate).

F1.11	Stator resistance of synchronous motor (reserved)	
	0.001~20.000Ω	Depending on model
F1.12	D-axis inductance of synchronous motor (reserved)	
	0.1~6553.5mH	Depending on model
F1.13	Q-axis inductance of synchronous motor (reserved)	
	0.1~6553.5mH	Depending on model
F1.14	Back-EMF constant of synchronous motor (reserved)	
	1~1000V/1000rpm	150
F1.15	Identification current of synchronous motor (reserved)	
	0%~30% rated current of motor	10%
F1.16	Motor tuning	
	0~3	0

0: no action

1: static tuning

Parameter measurement mode when motor stays in static state. This mode is suitable for condition where motor can't be apart from load.

2: complete tuning

A complete parameters measurement of motor. Choose this mode for best when motor can be apart from load.

Notice:

1: when set F1.16 as 2, if over current or tuning fault occurs during tuning, check if there is phase loss and whether the machine type matches;

2: when set F1.16 as 2, free motor shaft from load during complete tuning to prevent motor from complete tuning with load;

3: insure the motor staying at stopped state before activating motor parameter tuning, or it won't process normally;

4: in some condition (like that motor can't be detached from load) that complete tuning can't be conducted conveniently or no high requirement is asked for the motor control performance, static tuning can be used;

5: if tuning can't be conducted, users can input motor nameplate parameters (F1.01~F1.14) if they are acquired precisely, and the VFD can still demonstrate a high performance. If tuning fails, protection action will be activated and E-21 displayed.

F2 Group Speed Loop, Torque and Flux Control Parameter

F2.00	Speed loop (ASR1) ratio gain	
	0.000~6.000	1.000
F2.01	Speed loop (ASR1) integral time	
	0.000~32.000s	1.000

F2.02	ASR1 filter time constant	
	0.000~0.100s	0.000
F2.03	Switch low point frequency	
	0.00Hz~ 【F4.07】	5.00
F2.04	Speed loop (ASR2) proportional gain	
	0~6.000	1.500
F2.05	Speed loop (ASR2) integral time	
	0.00~32.000s	0.500
F2.06	ASR2 filer time constant	
	0.000~0.100s	0.000
F2.07	Switch high point frequency	
	【F4.03】 ~ 【F0.16】 upper limit freq.	10.00

Function codes F2.00~F2.07 are valid in no PG vector control mode.

In vector control mode, change speed response character by setting proportional gain P and integral time I of speed regulator. 1. Speed regulator (ASR) has structure as showed in figure F2-1. KP is proportional gain P, TI is integral time I.

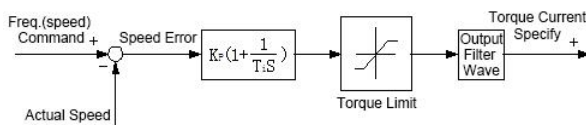

Fig. F2-1 Speed Regulator

F2.08	Vector control positive slip compensation factor (motoring condition)	
	50.0%~200.0%*rated slip freq.	100.0%
F2.09	Vector control negative slip compensation factor (braking state)	
	50.0%~200.0%*rated slip freq.	100.0%

In vector control mode, these above function codes are used to adjust steady-speed precision of motor. When motor is overload and the speed is low, increase the parameter, otherwise decrease the parameter.

Positive slip compensation factor works for the speed when motor slip ratio is positive, and negative slip compensation factor works for the speed when motor slip ration is negative.

F2.10	speed and torque control selection	
	0~2	0

0: speed control

Speed control when without PG current vector control.

1: torque control

Torque control when without PG current vector control, the relevant parameter setting is in F2.12~F2.24.

2: valid in condition (terminal switch)

The controlled object when without PG current vector control is controlled by discrete input terminal defined as speed and torque control switching. Refer to NO.48 item of F4 group discrete input terminal function description.

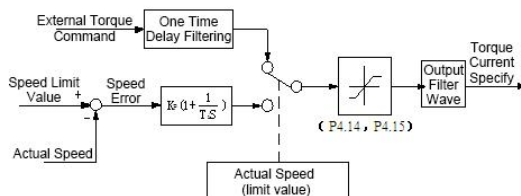

Figure F2-2 Torque Control Simplified diagram

F2.11	speed and torque switching delay	
	0.01~1.00s	0.05

This function defines the delay time switching from speed control to torque control or the other way around.

F2.12	Torque command	
	0~3	0

This function code is used to set reference input method of torque control.

0: keypad set

Torque command is given by keypad number. Set value is introduced in F2.13.

1: AI1

Torque command is set by analog input AI1. The positive or negative value of AI1 input correspond to torque command value of forward or reverse direction.

When using this function, users should set physical quantity of AI1 input as torque command, and also AI1 setting corresponding curve and AI1 input filtering time.

2: AI2

Torque command is set by analog input AI2. The positive or negative value of AI2 input correspond to torque command value of forward or reverse direction.

When using this function, users should set physical quantity of AI2 input as torque command, and also AI2 setting corresponding curve and AI2 input filtering time. R

3: RS485 communication

Torque command is given by RS485 communication.

F2.13	Torque set by keypad	
	-200.0%~200.0%* rated current of motor	0.0%

This function code corresponds to torque setting value when torque command is set to given by keypad number.

F2.14	Speed limit channel 1 of torque control mode (forward)	
	0~2	0

This function code is used to set forward speed limit channel of torque control.

0: keypad number setting 1:See F2.16 setting.

1: AI1

Forward speed limit channel is given by AI1 in torque control. See function code F2.00~F2.05.

2: AI2

Forward speed limit channel is given by AI2 in torque control. See function code F2.06~F2.11 description.

F2.15	Speed limit channel selection 2 of torque control mode (reverse)	
	0~2	0

This function code is used to set reverse speed limit channel of torque control. 0: keypad number setting 2

See F4.17 setting.

1: AI1

Reverse speed limit channel is given by AI1 in torque control. See function code F2.00~F2.05 description.

2: AI2

Reverse speed limit channel is given by AI2 in torque control. See function code F2.06~F2.11 description.

F2.16	Keypad limit speed 1	
	0.0~100.0%*【F0.10】max. freq.	100.0%

Keypad limit speed 1 is relative to the value of maximum output frequency. This function code corresponds to forward speed limit value when F2.14=0.

F2.17	Keypad limit speed 2	
	0.0~100.0%*【F0.10】max. freq.	100.0%

Keypad limit speed 2 is relative to the value of maximum output frequency. This function code corresponds to reverse speed limit value when F2.15=0.

F2.18	Torque rise time	
	0.0s~10.0s	0.1
	Torque decline time	

	0.0s~10.0s	0.1
--	------------	-----

Torque rise/decline time defines the time of torque rising from 0 to maximum value and falling from maximum value to 0.

F2.21	G type: 180.0% 0.0%~200.0%* rated current of motor P type: 120.0% 0.0%~200.0%*rated current of motor	Depending on model
F2.21	brake torque limit of vector mode G type: 180.0% 0.0 %~200.0 %*rated current of motor P type: 120.0% 0.0%~200.0%*rated current of motor	Depending on model

These above function codes defined the torque limit value of vector control.

F2.22	torque detection action 0~8	0
F2.23	torque detection level G type: 150.0% 0.0%~200.0%*rated current of motor P type: 110.0% 0.0%~200.0%*rated current of motor	Depending on model
F2.24	torque detection time 0.0~10.0s	0.0

When actual torque is within F2.24 (torque detection time) and continuously greater than F2.23 (torque detection level), the VFD will respond with corresponding action according to F2.22 setting. The torque detection value corresponds to the motor rated torque when set specified as 100%.

0: detection invalid

No torque detection is processed.

1: continue running after over-torque detected during constant speed running.

Only detect over-torque during constant speed running, and keep on running after it is detected.

2: continue running after over-torque detected during running

Detect over-torque during the whole running process, and keep on running after it is detected.

3: output cut off after over-torque detected during constant speed running

Over-torque is only detected during constant speed running, and after over-torque detected, the VFD will stop output and the motor will coast to stop.

4: output cut off after over-torque detected during running

Over-torque is detected during the whole running process, and after over-torque detected, the VFD will stop output and the motor will coast to stop.

5: continue running after insufficient torque detected during constant speed running

Only detect insufficient torque during constant speed running, and the VFD keeps on running after insufficient torque detected.

6: continue running after insufficient torque detected during running

Detect insufficient torque during the whole running process, and the VFD keeps on running after it is detected.

7: output cut off after insufficient torque detected during constant speed running

Only detect insufficient torque during constant speed running, and after it is detected, the VFD will stop output and the motor will coast to stop.

8: output cut off after insufficient torque detected during running

Detect insufficient torque during the whole running process, and after it is detected, the VFD will stop output and the motor will coast to stop.

F2.25	Cut off freq. of static friction coefficient	
	0.00~300.00Hz	10.00
F2.26	Static friction coefficient set	
	0.0~200.0	0.0
F2.27	Hold time of static friction coefficient	
	0.00~600.00s	0.0

As the starting torque of the motor is not enough and the setting value of F2.26 is increased, the starting torque can be increased. When the speed exceeds the set value of F2.25, the added torque will slowly fall to a given torque in the setting time of F2.27.

F3 Group VF control parameter

F3.00	V/F curve setting	
	0~5	0

This group of parameters are used to define motor V/F setting mode to cater for different load characteristic. Five fixed curves and one user-defined curve can be selected according to the setting of F3.00.

0: linear curve

Linear curve is suitable for common constant torque type load, output voltage and output frequency are in linear relation, as straight line 0 showed in Fig. F3-1.

1: decreasing torque curve 1 (power of 1.3)

Decreasing torque curve 1, output voltage value is output frequency value to the power of 1.3, as curve 1 showed in Fig. F3-1.

2: decreasing torque curve 2 (power of 1.5)

Decreasing torque curve 2, output voltage value is output frequency value to the power of 1.5, as curve 2 showed in Fig.F3-1.

3: decreasing torque curve 3 (power of 1.7)

Decreasing torque curve 3, output voltage value is output frequency value to the power of 1.7, as curve 3 showed in Fig.F3-1.

4: square curve

Square curve is suitable for square torque type load such as draught fan and water pump to achieve the optimum energy-saving effect. Output voltage value is output frequency value to the second power, as curve 4 showed in Fig. F3-1.

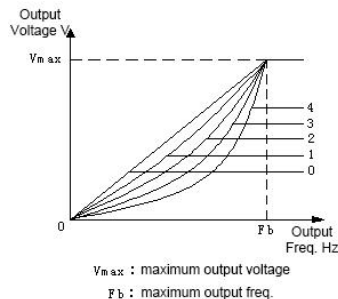

Fig. F3-1 V/F Curve 5: user-defined V/F curve (determined by

5. When set F3.00 as 5, users can customize V/F curve via F3.03 ~ F3.08, by adding (V1,F1),(V2,F2),(V3,F3), origin, and max. freq. point to form a broken line, so as to meet special load characteristic. The curve is as showed in Fig. F3-2

F3.01	torque compensation set	
	0.0~30.0%motor rated voltage	Type setting
F3.03	torque compensation cut-off frequency	
	0.0~motor rated power	50.00

To compensate for low frequency torque characteristics, it is feasible to boost output voltage. This function code indicates automatically torque compensation with set value of 0.0% and manual torque compensation with any set value other than 0.0%. F3.02 defines cut-off frequency fz of manual torque compensation, as showed in Fig. F3-3 (Vb is manual boost voltage).

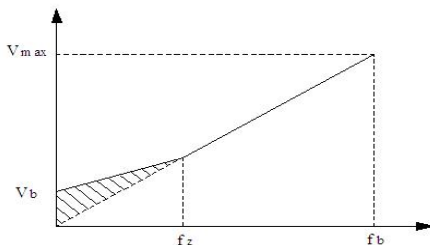

Fig. F3-3 Torque Boost

Notice:

- 1: in common V/F mode, auto torque boost mode is invalid.
- 2: auto torque boost mode is only valid in advanced V/F mode.

F3.03	V/F frequency value F1	
	0.00~frequency value F2	12.50
F3.04	V/F voltage value V1	
	0.0~voltage value V2	25.0%
F3.05	V/F frequency value F2	
	Frequency value F1~frequency value F3	25.00
F3.06	V/F voltage value V2	
	Voltage value V1~voltage value V3	50.0%
F3.07	V/F frequency value F3	
	Frequency value F2 ~ motor rated frequency	37.50
F3.08	V/F voltage value V3	
	Voltage value V2~100.0%*motor rated voltage	75.0%

Voltage and frequency is as showed in Fig. F3-4.

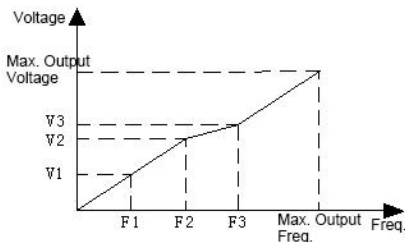

Fig. F3-4 User Setting V/F Curve

F3.09	V/F control slip frequency compensation	
	0.0~200.0%*rated slip	0.0%

The speed of asynchronous motor will decrease after loading, but can approach synchronous speed by slip compensation, so as to improve the control precision of motor speed; the default rated slip in vector V/F control mode is 100.0%.

F3.10	V/F control slip frequency filtering coefficient	
	1~10	3

This parameter is used to adjust the response speed of slip frequency compensation. The greater of this set value, the slower of the response speed, and the steadier the motor speed.

F3.11	V/F control torque frequency compensation filtering coefficient	
	0~10	0

In auto torque boost mode, this parameter is used to adjust response speed of torque compensation. The greater of this set value, the slower of the response speed, and the steadier the motor speed.

F3.12	Separated type V/F control selection	
	0~3	0

0: VF half separated mode, open loop voltage output

In this control mode, VFD starts in normal V/F curve, and adjusts voltage to value of set target voltage after reaching set frequency point. No feedback for voltage in this mode, and the target voltage value is open loop setting.

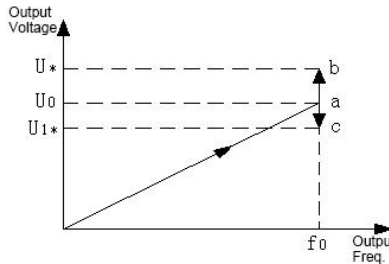

Fig. F3-4 Voltage Control Mode 0

F0—set frequency, V0—corresponding rated voltage of set frequency, U*/U1*—F3.13setting value of given channel.

As showed in the above figure, the voltage is adjusted after stabilization of point a frequency. According to value of target voltage and input voltage, the voltage point may move towards point b (increase) or point c (decrease), until reaching target value.

1: VF half separated mode, voltage closed-loop output

The only difference of this mode from mode 0 is that it introduced voltage closed-loop. Through PI adjustment of deviation of feedback voltage compared with set voltage, a steadier voltage can be acquired. This method can compensate target voltage deviation caused by load change, so as to acquire a higher precision of voltage control and a faster response.

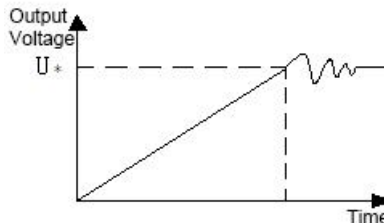

Fig. F3-5 Voltage Control Mode 1

This control mode is widely applied in areas like EPS power source. The control principle is as showed in the following wireframe figure

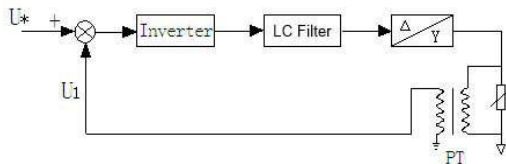

Fig. F3-6 EPS Control Principle

U^* ——setting value of P3.13 channel

U_1 ——analog feedback voltage (PT) PT——electrical quantity transducer

Notice:

Analog feedback channel voltage has a corresponding relation F6.06~F6.11 with actual voltage, and the relation is only determined by voltage transducer (PT), the computational method is as follows:

Hypothetically $U^*=120\%*U_e=456V(A11)$

PT ratio=50 (input AC 0-500V, output DC 0-10V)

When output reaching the target voltage 456V, the feedback voltage of PT output is $456/50V=9.12V$

A11 upper limit input is 10V, input voltage is 500V, the ratio to rated voltage value is $500/380=132\%$

So (AI2 input upper limit voltage) can be set as 10.00V, (AI2 upper limit corresponding setting) can be set at 132%.

2: VF fully separated mode, voltage open-loop output

In this mode, output frequency and voltage of VFD are completely independent. Frequency changes according to set acc/dec time, voltage is adjust to target value according to rise/fall time defined by F3.19, F3.20, as showed in figure F5-7. This control mode is mainly applied in designing of some variable-frequency power source.

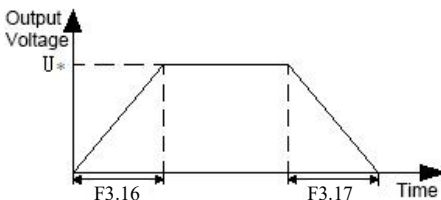

Fig. F3-7 Voltage Control Mode 2

3: VF fully separated mode, voltage closed-loop output

The only difference of this mode from mode 2 is that it introduced voltage closed-loop. Through PI adjustment of deviation of feedback voltage compared with set voltage, a steadier voltage can be acquired. This method can compensate target voltage deviation caused by load change, so as to acquire a higher precision of voltage control and a faster response.

F3.13	voltage setting channel	
	0~2	0

0: digital setting

Set the target voltage value by function code F3.14.

1: AI1

Specify target voltage value by analog quantity AI1, and the corresponding physical quantity F4.28 of AI1 should be set as 2 (voltage directive).

2: AI2

Specify target voltage value by analog quantity AI2, and the corresponding physical quantity F4.29 of AI2 should be set as 2 (voltage directive).

F3.14	output voltage of digital setting	
	0.0~200.0%*motor rated voltage	100%

This parameter is used to limit the error amplitude of voltage regulation in close-loop mode, so as to keep the voltage in the safe range and the equipment working reliably.

F3.15	VF curve max. voltage of half separated mode	
	0.0~100.0%*motor rated voltage	80.0%

This function defined the maximum voltage point when starting the equipment with voltage and frequency curve. An appropriate setting of this function could prevent voltage overshoot effectively to ensure reliable operation.

F3.16	Voltage rising time	
	0.1~3600.0s	10.0
F3.17	Voltage declining time	
	0.1~3600.0s	10.0

This function code defined the rising and falling time of voltage in the V/F fully separated control mode 2.

F4 Group - Digital Input Parameters

F4.00	Input terminal X1 function (when F8.21 is non-zero, default as function NO.58)	
	0~99	1
F4.01	Input terminal X2 function (when F8.21 is non-zero, default as function NO.59)	
	0~99	2
F4.02	Input terminal X3 function (when F8.21 is non-zero, default as function NO.60)	
	0~99	4
F4.03	Input terminal X4 function (when F8.21 is non-zero, default as function NO.61)	
	0~99	7
F4.04	Input terminal X5 function (when F8.21 is non-zero, default as function NO.62)	
	0~99	8
F4.05	Input terminal X6 function (when F8.21 is non-zero, default as function NO.63)	
	0~99	0
F4.06	Input terminal X7 function	
	0~99	45
F4.07	reserved	
	—	0

0: control terminal idle

1: forward running (FWD)

Short-circuit terminal with COM, VFD runs forward. Valid only when F0.02=1.

2: reverse running (REV)

Short-circuit terminal with COM, VFD runs reverse. Valid only when F0.02=1.

3: three-wire running control

Refer to function description of running mode 2, 3 (three-wire control mode 1, 2) of F4.11.

4: forward jog control

Short-circuit terminal with COM, VFD runs as jog forward. Valid only when F0.02=1.

5: reverse jog control

Short-circuit terminal with COM, VFD runs as jog reverse. Valid only when F0.02=1.

6: coast to stop

This function is the same with F6.08. Only that it is realized by terminal and convenient for remote control.

7: external reset signal input(RST)

If the VFD malfunctions, it can be reset through this terminal. This function is the same with key **STOP/RESET**, and is valid in any command channel.

8: external fault normally-open input

9: external fault normally-closed input

The fault signal of external device can be input through this terminal so as to facilitate fault monitoring of external device. After receiving fault signal of external device, VFD will display “E-19” (external device fault alarm). The fault signal can be input with two methods of normally open and normally closed.

10: emergency stop function (brake with fastest speed)

This function is used in emergency stop condition. The terminal is short-circuited with COM, and the braking will proceed with emergency standby decreasing time (F8.23).

11: reversed

12: frequency increase

Terminal is short-circuited with COM, frequency increases. Valid only when frequency setting channel is digital setting 2 (terminal UP/DOWN adjustment).

13: frequency decrease

Terminal is short-circuited with COM, frequency decreases. Valid only when frequency setting channel is digital setting 2 (terminal UP/DOWN adjustment).

14: UP/DOWN terminal frequency zero clearing

Conduct zero clearing to digital frequency 2 (UP/DOWN terminal adjustment) increment through terminal.

15: multi-speed selection 1

16: multi-speed selection 2

17: multi-speed selection 3

18: multi-speed selection 4

By selecting ON/OFF combination of these function terminals, 16 segments of speed at most can be achieved, as showed in the following table:

Multi-speed selection SS4	Multi-speed selection SS3	Multi-speed selection SS2	Multi-speed selection SS1	Speed segment
OFF	OFF	OFF	OFF	0
OFF	OFF	OFF	ON	1
OFF	OFF	ON	OFF	2
OFF	OFF	ON	ON	3
OFF	ON	OFF	OFF	4
OFF	ON	OFF	ON	5
OFF	ON	ON	OFF	6
OFF	ON	ON	ON	7
ON	OFF	OFF	OFF	8
ON	OFF	OFF	ON	9
ON	OFF	ON	OFF	10
ON	OFF	ON	ON	11
ON	ON	OFF	OFF	12
ON	ON	OFF	ON	13
ON	ON	ON	OFF	14
ON	ON	ON	ON	15

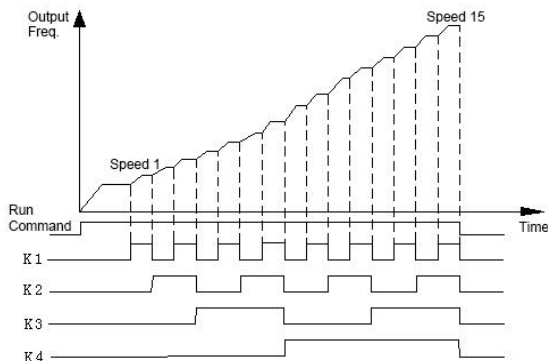

Figure F7-1 Multi-speed Running

19: Acc/Dec time selection TT1

20: Acc/Dec time selection TT2

selecting the ON/OFF combination of these function terminals, there would be 4 kinds of acc/dec time at most, as showed in the following table:

Acc/Dec time selection terminal 2	Acc/Dec time selection terminal 1	Acc/Dec time selection
OFF	OFF	Acc time 1/Dec time 1
OFF	ON	Acc time 2/Dec time 2
ON	OFF	Acc time 3/Dec time 3
ON	ON	Acc time 4/Dec time 4

21: run command channel 1

22: run command channel 2

By selecting the ON/OFF combination of these function terminals, there would be 3 kinds of run command channels and 4 kinds of methods at most, as showed in the following table

Run command channel selection terminal 2	Run command channel selection terminal 1	Run command channel
OFF	OFF	Determined by function code P0.02
OFF	ON	0: keypad
ON	OFF	1: terminal
ON	ON	2: communication

23: Acc/Dec prohibit

When this terminal is valid, VFD will maintain current frequency without influence of external signal (except stop command).

24: VFD operating prohibiting

If this function is enabled, the drive that is operating will coast to stop and the drive ready to run will be prohibited to start. This function is mainly used as safety protection.

25: switch operating command to keypad

When this terminal function is enabled, the operating command is switched to keypad control from present channel forcibly. If the terminal is disconnected, the previous operating command channel will be enabled.

26: switch operating command to terminal

When this terminal function is enabled, the operating command is switched to terminal control from present channel forcibly. If the terminal is disconnected, the previous operating command channel will be enabled.

27: switch operating command to communication

When this terminal function is enabled, the operating command is switched to communication control from present channel forcibly. If the terminal is disconnected, the previous operating command channel will be enabled.

28: clear the setting of auxiliary frequency

This function is only valid for digital auxiliary frequency (F0.04=0, 1, 2) to clear it to zero, so that the reference frequency is determined solely by main reference.

29: switch from frequency source A to $K \cdot B$

When this terminal function is enabled, if F0.05 (frequency combinational algorithm) is set as 6, the frequency setting channel is switched to frequency source B, and back to A when it is disabled.

30: switch from frequency source A to $A + K \cdot B$

When this terminal function is enabled, if F0.05 (frequency combinational algorithm) is set as 7, the frequency setting channel is switched to frequency source ($A + K \cdot B$), and back to A if it is disabled.

31: switch from frequency source A to $A - K \cdot B$

When this terminal function is enabled, if F0.05 (frequency combinational algorithm) is set as 8, the frequency setting channel is switched to frequency source ($A - K \cdot B$), and back to A if it is disabled.

32: reserved

33: PID control input

This terminal function is enabled when frequency is input via PID manually. Refer to FA group parameter setting for details.

34: PID control pause

This terminal function is used for pause control of operating PID. When it is enabled, PID adjustment will stop and the VFD remain the present frequency. Continue PID adjustment when the function is disabled, the running frequency will change to the adjustment.

35: start traverse operation

If the traverse operation is set to be manual start, then traverse function is enabled if this function is selected. Otherwise the VFD runs with preset frequency of traverse operation. Refer to FB.00~FB.10.

36: pause traverse operation

Short-circuit the terminal with COM, the VFD will stop the traverse operation and remain the present frequency; if the terminal is disabled, the VFD will resume traverse operation.

37: traverse reset

If this function is selected, closing the terminal can clear the information about traverse status no matter the drive is in auto or manual start mode. Traverse operation continues after this terminal is disconnected (run preset freq. if there is preset freq.). See FB.00~FB.10.

38: PLC control input

This terminal function is enabled when PLC input method is manual input method via multi-function terminal, and PLC operates normally when operating command arrives; if the terminal function is disabled, the VFD runs in zero frequency when operating command arrives.

39: PLC pause

It is used to pause the PLC operation. The driver will operate at zero frequency if this terminal is enabled, but the running time is not counted; if the terminal is disabled, the driver will start in rotating speed tracking method and continue the PLC operation. Refer to FC.00~FC.53 for function description.

40: PLC status reset

When the drive stops in PLC mode and this terminal function is enabled, the memorized PLC operating information (operating stage, operating time, operating frequency, etc.) will be cleared. The driver will restart if the terminal function is disabled. See FC.

41: clear the counter to zero

Short-circuit the terminal with COM, this function is to clear to zero and is used in conjunction with function NO.42.

42: input signal to trigger the counter

This terminal is used to input counting pulse signal to the internal counter of the driver. The counting value increase by 1 each time receiving one impulse (decrease by 1 for down-counting). The max. pulse frequency is 200Hz. See FB.19~ FB.22.

43: timing trigger input

Trigger port of internal timer. See FB.23~FB.25.

44: timing zero clearing

Short-circuit the terminal with COM, this terminal is to clear the internal timer to zero and is used in conjunction with function NO.43.

45: external impulse frequency input (only effective to X6)

This function terminal is pulse input port of principle frequency channel A, and is only effective to X6, and is used in conjunction with F0.07.

46: clear the length information

When this function terminal is effective, the information of F9.69 (actual length) will be cleared to get prepared for recounting. See FB.12~FB.18.

47: Input the signal of length (only effective to X6)

This function is effective only to multi-function input terminal X6, and the impulse signal received by this function terminal works as length setting. The number of received impulse has a connection with the length, which is introduced in FB.13~FB.18

48: switch speed and torque control

When selection condition (terminal switch) of speed and torque control is valid, this terminal is effective and torque control is on; if this terminal is ineffective, the speed control is on. See F2.10~F2.11 for relevant parameter setting (F4.11 is the delay time of speed and torque switch).

49: prohibit torque control Torque control is prohibited.

50~55: reserved

56~57: reserved 58: start/stop (manual)

When this terminal is valid, frequency is given by AII, PID control is not conducted, and controlled by interlock signal. The earlier input interlock signal will start first. If input together, start the one corresponding smaller number.

59: running allowed (X2)

This terminal is used to control start/stop of VFD, normally connecting signal of external water shortage or high voltage.

60: interlock1 (X3)

This terminal connection corresponds relay R2 output.

61: interlock2 (X4)

This terminal connection corresponds relay R3 output.

62: interlock3 (X5)

This terminal connection corresponds relay R4 output.

63: PFC start/stop (X6)

When this terminal is valid, PID control is conducted, and controlled by interlock signal. The earlier input interlock signal will start first. If input together, start the one corresponding smaller number.

64: A frequency switch B and run

65~99: reserved

F4.08	digital filtering times	
	1~10	5

This function is used to set sensitivity of input terminal. If digital input terminal is susceptible to interference so as to cause error action, increase this parameter to improve the anti-interference ability, but overlarge value will result in a lower sensitivity.

F4.09	Terminal function detection when powerup	
	0~1	0

0: terminal control invalid when powerup

During powering up, even detected that the terminal of operation command is valid (closed), the driver will not start; only when the terminal closed again after disconnected, the driver will start.

1: terminal control valid when powerup

During powerup, the driver will start if the terminal is detected valid (closed).

F4.10	Effective logic setting of input terminal (X1~X7)	
	0~FFH	00

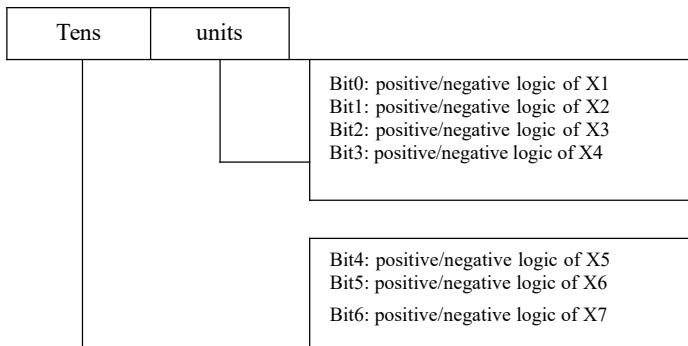

0: positive logic, which refers that the terminal Xi is enabled when it connects with the common port and disabled if disconnected.

1: negative logic, which refers that the terminal Xi is disabled when it connects with the common port and enabled if disconnected.

F4.11	FWD/REV terminal control mode	
	0~3	0

This function code defines 4 kinds of modes of controlling VFD operation via external terminal.

0: 2-wire control mode 1

Xm: forward command (FWD); Xn: reverse command (REV). Xm and Xn are two random terminals among X1-X8 defined as FWD and REV function respectively. In this control mode, K1 and K2 can both control operation and direction of the driver independently.

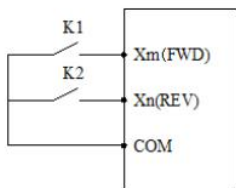

K2	K1	Run Command
0	0	Stop
0	1	forward FWD
1	0	Stop
1	1	reverse REV

Fig. F4-2 2-wire Control Mode 1

1: 2-wire control mode 2

Xm: forward command (FWD); Xn: reverse command (REV). Xm and Xn are two random terminals among X1-X7 defined as FWD and REV function respectively. In this control mode, K1 is switch of run and stop, K2 is for direction switching.

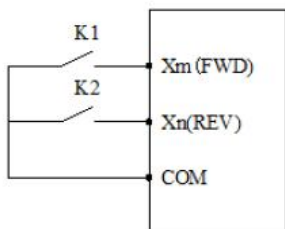

K2	K1	Run Command
0	0	Stop
0	1	forward FWD
1	0	Stop
1	1	reverse REV

Fig. F4-3 2-wire Control Mode 2

2: 3-wire control mode 1

Xm: forward command (FWD); Xn: reverse command (REV); Xx: stop command. Xm, Xn and Xx are 3 random terminals among X1-X8 defined as FWD, REV and 3-wire control function respectively. K1 and K2 are invalid without connecting of K3. After K3 is connected, K1 is triggered, and the VFD runs forward; disconnect K3, then the VFD will stop.

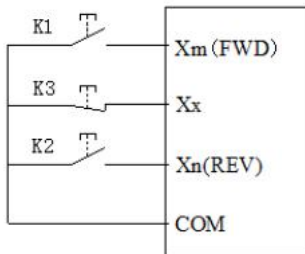
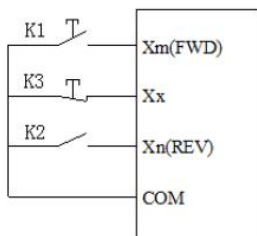

Fig. F4-4 3-wire Control Mode 1

3: 3-wire control mode 2

Xm: operating command; Xn: running direction; Xx: stop command. Xm、Xn、Xx are 3 random terminals among X1-X8 defined as FWD, REV and 3-wire control function. K1 and K2 are invalid without connection of K3. After K3 is connected, trigger K1, and the VFD runs forward; triggering K2 alone is invalid; trigger K2 after K1, the driver will switch its running direction; disconnect K3, the driver will stop



K2	K1	Run Command
0	0	Stop
0	1	forward FWD
1	0	reverse REV
1	1	Outage

Notice

When forward running with 3-wire control mode 2, the VFD can reverse steadily only if the REV terminal is normally closed, once disconnected of the terminal, the driver will runs forward

F4.12	UP/DOWN terminal frequency modifying rate	
	0.01 ~ 50.00Hz/S	1.00

This function code is used to setting the frequency modifying rate of UP/DOWN terminal, i.e. the changed value of frequency when short-circuit UP/DOWN terminal with COM for one second.

When F0.18=1 (high frequency mode), the upper limit value of this function code is 500.0Hz/s.

F4.13	All input lower limit	
	0.00V/0.00mA ~ 10.00V/20.00mA	0.00
F4.14	All lower limit corresponding physical quantity setting	
	-200.0% ~ 200.0%	0.0%
F4.15	All input upper limit	
	0.00V/0.00mA ~ 10.00V/20.00mA	10.00
F4.16	All upper limit corresponding physical quantity setting	
	-200.0% ~ 200.0%	100.0%
F4.17	All input filtering time	
	0.00s ~ 10.00s	0.05

All analog setting value works as given value of torque command, which ranges -200.0% ~ 200.0%. For relevant setting see F6 group function code description.

2: voltage command (output voltage, 0.0% ~ 200.0% * motor rated voltage)

F4.18	AI2 input lower limit	
	0.00V ~ 10.00V	0.00

F4.19	AI2 lower limit corresponding physical quantity setting	
	-200.0%~200.0%	0.0%
F4.20	AI2 input upper limit	
	0.00V~10.00V	10.00
F4.21	AI2 upper limit corresponding physical quantity setting	
	-200.0%~200.0%	100.0%
F4.22	AI2 input filtering time	
	0.00s~10.00s	0.05

These above function codes defined input range of analog input voltage channel AI1, AI2, and the corresponding physical quantity percentage and filtering time constant. AI1 can be chosen as voltage/current input via J1 wire jumper, and the digital setting can be based on the relation of 0~20mA in accordance with 0~10V. The specific setting should be depended on the actual condition of input signal.

AI1, AI2 input filtering time constant are used for filtering process of analog input signal, thus eliminating the disturbing influence. The greater of the time constant, the better of the anti-interference ability, and the steadier of the control, but the slower of the response; otherwise, the smaller of the time constant, the faster of the response, but the weaker of the anti-interference ability, and the control may not be steady. If the optimum value can't be decided in practical application, make appropriate adjustment for this parameter based on whether the control is steady and response delay condition.

F4.23	External impulse input lower limit	
	0.00~50.00KHz	0.00
F4.24	External impulse lower limit corresponding physical quantity setting	
	-200.0%~200.0%	0.0%
F4.25	external impulse input upper limit	
	0.00~50.00KHz	20.00
F4.26	external impulse upper limit corresponding physical quantity setting	
	-200.0%~200.0%	100.0%
F4.27	external impulse input filtering time	
	0.00s~10.00s	0.05

These above function codes defined input range of impulse input channel and the corresponding physical quantity percentage. Multi-function terminal X6 must be defined as "impulse frequency input" function.

Impulse input filtering time constant are mainly used for filtering process of impulse signal. The principle is the same with analog input filtering time constant.

F4.28	AI1 input corresponding physical quantity	
	0~2	0

0: speed command (output frequency, -100.0%~100.0%)

1: torque command (output torque, -200.0%~200.0%)

F4.29	AI2 input corresponding physical quantity	
	0~2	0

0: speed command (output frequency, -100.0%~100.0%)

1: torque command (output torque, -200.0%~200.0%)

F4.30	External impulse input corresponding physical quantity	
	0~1	0

0: speed command (output frequency, -100.0%~100.0%)

1: torque command (output torque, -200.0%~200.0%)

F4.31	Error limit of analog input	
	0.00V~10.00V	0.10

When analog input signal shows frequent fluctuation around the set point, set F6.12 to restrain the frequency fluctuation caused by this fluctuation.

F4.32	Threshold of zero-frequency operation	
	Zero-frequency hysteresis ~50.00Hz	0.00

When F0.18=1 (high frequency mode), the upper limit of this function code is 500.0Hz.

F4.33	Zero-frequency hysteresis	
	0.00 ~ zero-frequency running threshold value	0.00

These two function codes are used to set zero-frequency hysteresis control function. Take analog AI1 current setting channel for example, as showed in Fig. F4-6.

Start process:

After start command is sent, only when analog AI1 current input reaches or exceeds value I_b and the according frequency reaches f_b , the motor can start and speed up according to accelerating time until reaching the according frequency of analog AI1 current input.

Stop process:

When AI1 current falls to value I_b during running, the VFD won't stop immediately. Only when AI1 current falls to I_a and the according setting frequency is f_a , the VFD will stop output. This f_b is defined as zero-frequency running threshold value, determined by F4.32; f_b-f_a is defined as zero-frequency hysteresis, determined by F4.33.

This function can achieve sleep function and maintain an energy-saving operation, and avoid frequent fluctuation around threshold frequency through hysteresis width.

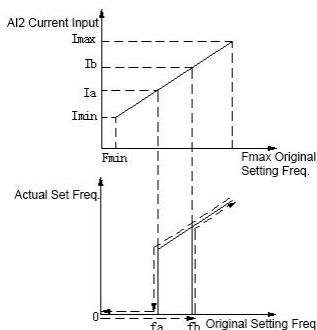

f_b : zero frequency running threshold value f_a : f_b - zero frequency backlash

Fig. F4-6 zero-frequency function schematic diagram

F5 Group - Digital Output Parameters

F5.00	Open collector output terminal Y1	
	0~99	0
F5.01	Open collector output terminal Y2	
	0~99	0
F5.02	Programmable relay R1 output	
	0~99	3
F5.03	Programmable relay R2 output	
	0~99	0

0: no output

1: VFD forward running

The indicator signal output when the VFD is in forward running.

2: VFD reverse running

The indicator signal output when the VFD is in reversing running.

3: fault output

The indicator signal output when the VFD fault occurs.

4: freq./speed level detection signal (FDT1)

Refer to F8.26~F8.27 function description.

5: freq./speed level detection signal (FDT2)

Refer to F8.29~F8.31 function description.

6: freq./speed arrival signal (FAR) Refer to F8.25 function description.

7: indicator during zero-speed running

The indicator signal output when VFD is still in running state and output frequency is 0.00Hz.

8: upper limit arrival of output frequency

The indicator signal output when VFD output frequency reached its upper limit.

9: lower limit arrival of output frequency

The indicator signal output when VFD output frequency reached its lower limit.

10: lower limit arrival of preset frequency

The signal is given if the preset frequency is lower than lower limit during VFD running.

11: pre-alarm signal of overload

The signal is given after alarm-delay time (F9.12) if the output current is higher than overload pre-alarm level (F9.13).

12: counter detection signal output

The indicator signal is given when counter detection value arrives, and it is cleared when reset value of counter arrives. See FB.22.

13: counter reset signal output

The indicator signal is given when counter reset value arrives. See FB.21.

14: driver ready

This signal is output when the driver has no fault, its bus voltage is normal, the start prohibit function is disabled, so that the driver is ready to start for direct command.

15: one cycle finished of programmable multi-speed running

After one cycle of programmable multi-speed (PLC) run is finished, one effective impulse signal is sent with width of 500ms.

16: programmable multi-speed stage finished

After the present stage of programmable multi-speed (PLC) is finished, one effective impulse signal is sent with width of 500ms.

17: upper and lower limit of traverse frequency

When traverse frequency function is selected, if the fluctuation range of traverse frequency counted based on central frequency exceeds upper limit F0.11 or lower limit F0.12, this indicator signal will be sent. As showed in the following figure.

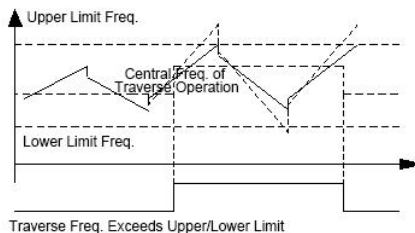

18: current limiting action

This signal is sent when VFD is during current limiting. See F9.06~F9.08 for limiting protection setting.

19: stall over voltage

This signal is sent when VFD is in action of stall over voltage. See F9.04 for the corresponding protection setting.

20: low voltage lock-up

This signal is output when DC bus voltage is lower than the low voltage limit.

Notice:

When undervoltage of DC bus happens during stopping, the LED displays “PoFF”; when it happens during running, if FA.02=0, the LED displays “PoFf”, if F9.02=1, the LED displays “E-07” and the alarm indicator is on.

21: dormancy state

This signal is sent when the VFD is in dormancy state.

22: VFD alarm signal

This signal is sent when the following situation happens: PID disconnection, RS485 communication fail, keypad communication fail, EEPROM R/W fault, encoder disconnection, etc.

23: AI1 > AI2

This indicator signal is sent when analog input AI1 > AI2.

24: preset length arrival

This signal is given when the actual length (FB.14) \geq preset length (FB.13). The length counting terminal X6 is set as function of NO.47.

25: preset timing time arrival

This signal is give when the actual timing time \geq FB.25 (preset timing time).

26: dynamic braking

This signal is sent when the VFD is in dynamic braking action. See FE.00~FE.03.

27: DC braking action

This signal is sent when the VFD is in DC braking action. See description of function code F6.00~F6.12 for corresponding setting.

28: flux braking action

This signal is sent when the VFD is in flux braking action. Refer to function code FE.21 for corresponding setting.

29: torque limiting

This signal is sent during torque control. Refer to F2.10~F2.23.

30: over torque

This indicator signal is sent according to F2.22~F2.24 setting.

31: auxiliary motor 1

32: auxiliary motor 2

The function of constant pressure water supply can be realized by auxiliary motor 1,2 and PID function module.

33: total operating time arrival

This signal is sent when the operating limit time (FE.11) arrives.

34~49: multi-speed or PLC running segment

The output terminal function 34~49 items correspond to 0~15 segments of multi-speed or simple PLC, and this signal is sent when the corresponding segment of output terminal setting arrives.

50: VFD running indication

Indication signal output when VFD is in in forward/reverse running state.

51: temperature arrival indication

This signal is sent when actual temperature (d-33~d-34) is higher than threshold temperature (F9.14).

52~99: reserved

F5.04	AO1 multi-function analog output terminal	
	0-13	0
F5.05	AO2 multi-function analog output terminal	
	0-13	4
F5.06	DO multi-function impulse output terminal	
	0-13	11

These above function codes determined the corresponding relation of multi-function analog output terminal AO, impulse output terminal DO with each physical quantity. As showed in the following table:

item	AO1	range
Output freq.(before slip compensatio)	0V/0mA~AO upper limit	0~max. output freq.
	2V/4mA~AO upper limit	0~max. output freq.

Output freq.(after slip compensatio)	0V/0mA~AO upper limit	0~max. output freq.
	2V/4mA~AO upper limit	0~max. output freq.
Set freq.	0V/0mA~AO upper limit	0~max. output freq.
	2V/4mA~AO upper limit	0~max. output freq.
Motor speed	0V/0mA~AO upper limit	0~motor synchronous speed
	2V/4mA~AO upper limit	0~motor synchronous speed
Output current	0V/0mA~AO upper limit	0~2 times of rated current
	2V/4mA~AO upper limit	0~2 times of rated current
Output voltage	0V/0mA~AO upper limit	0~1.2 times of rated output voltage
	2V/4mA~AO upper limit	0~1.2 times of rated output voltage
Bus voltage	0V/0mA~AO upper limit	0~800V
	2V/4mA~AO upper limit	0~800V
PID set value	0V/0mA~AO upper limit	0~100%*10V
	2V/4mA~AO upper limit	0~100%*20mA
PID feedback value	0V/0mA~AO upper limit	0~100%*10V
	2V/4mA~AO upper limit	0~100%*20mA
AI1	0V/0mA~AO upper limit	0~10V
	2V/4mA~AO upper limit	0~10V
AI2	0V/0mA~AO upper limit	0~20mA
	2V/4mA~AO upper limit	0~20mA
Input impulse frequency	0V/0mA~AO upper limit	0~50KHZ
	2V/4mA~AO upper limit	0~50KHZ
Torque current	0V/0mA~AO upper limit	0~2 times of rated current
	2V/4mA~AO upper limit	0~2 times of rated current
Flux current	0V/0mA~AO upper limit	0~2 times of rated current
	2V/4mA~AO upper limit	0~2 times of rated current

DO range: DO lower limit~DO upper limit, correspond separately to upper limit and lower limit of each physical quantity.

F5.07	corresponding physical quantity of AO1 output lower limit	
	-200.0%~200.0%	0.0%
F5.08	AO1 output lower limit	
	0.00~10.00V	0.00
F5.09	Corresponding physical quantity of AO1 output upper limit	
	-200.0%~200.0%	100.0%
F5.10	AO1 output upper limit	
	0.00~10.00V	10.00
F5.11	Corresponding physical quantity of AO2 output lower limit	
	-200.0%~200.0%	0.0%
F5.12	AO2 output lower limit	
	0.00~10.00V	0.00
F5.13	Corresponding physical quantity of AO2 output upper limit	
	-200.0%~200.0%	100.0%
	AO2 output upper limit	

	0.00~10.00V	10.00
F5.15	Corresponding physical quantity of DO output lower limit	
	-200.0%~200.0%	0.0%
F5.16	DO output lower limit	
	0.00~50.00kHz	0.00
F5.17	corresponding physical quantity of DO output upper limit	
	-200.0%~200.0%	100.0%
F5.18	DO output upper limit	
	0.00~50.00kHz	50.00
F5.19	Effective logic setting of output terminal (Y1~Y2)	
	0~3H	0

Bit0: effective logic definition of Y1 terminal Bit1: effective logic definition of Y2 terminal

0: positive logic, i.e. Yi terminal is enabled when it connects with common terminal and disabled if disconnected.

1: negative logic, i.e. Yi terminal is disabled when it connects with common terminal and enabled if disconnected.

When F5.19=0, Y1 and Y2 terminals are enabled when they connect with common terminal and enabled if disconnected.

When F5.19=1, Y1 terminal is disabled when it connect with common terminal and enabled if disconnected; Y2 terminal is disabled when it connect with common terminal and enabled if disconnected.

When F5.19=2, Y1 terminal is enabled when it connect with common terminal and disabled if disconnected; Y2 terminal is disabled when it connect with common terminal and enabled if disconnected.

When F5.19=3, Y1 and Y2 terminals are disabled when they connect to common terminal and enabled if disconnected.

F5.20	Y1 output delay time	
	0.0~100.0s	0.0
F5.21	Y2 output delay time	
	0.0~100.0s	0.0
F5.22	R1 output delay time	
	0.0~100.0s	0.0
F5.23	R2 output delay time	
	0.0~100.0s	0.0

This function code defines digital output terminal and the delayed time from relay condition changing to output changing.

F5.24	Y1 turn off delay time	
	0.0~100.0s	0.0
F5.25	Y2 turn off delay time	
	0.0~100.0s	0.0
F5.26	R1 turn off delay time	
	0.0~100.0s	0.0
F5.27	R2 turn off delay time	
	0.0~100.0s	0.0

F6 Group - Auxiliary Operating Parameters

F6.00	Start mode	
	0~2	0

0: start at start frequency

Start with start frequency (F6.01) and its corresponding retention time (F6.02) that has been set. 1: DC braking and start at start frequency

DC brake (F6.03, F6.04) first, then start in method 0. 2: start with speed tracking

When power on after power off, if it meets the starting condition, after a period of time defined by FE.15, the VFD will start automatically in speed tracking method.

F6.01	Start frequency	
	0.00~50.00Hz	1.00
F6.02	Start frequency hold time	
	0.0~10.0s	0.0

Start frequency is the initial frequency when the VFD starts, as f_s showed in the following figure. For some system with relatively big starting torque, a reasonably set start frequency can solve effectively the hard starting problem. The retention time of start frequency is the time VFD stays in the start frequency value during starting stage, as t_1 showed in the following figure.

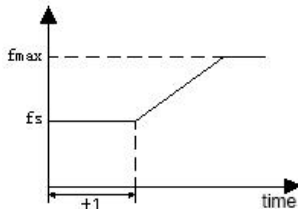

Figure F6-1 Start Frequency

Notice:

Start frequency is not effective by lower limit frequency. Jog frequency is not effective by lower limit frequency but is restricted by start frequency.

When F0.18=1 (high frequency mode), start frequency has a upper limit of 500.0Hz

F6.03	DC brake current at startup	
	0.0~150.0%*rated current of motor	0.0%
F6.04	DC brac time at startup	
	0.0~100.0s	0.0

The setting value of start DC brake current is the percentage relative to rated output current. When start DC brake time is 0.0s, there would be no DC brake process.

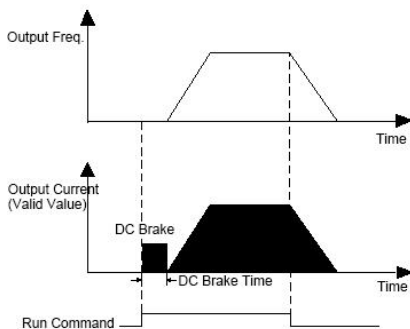

Figure F6-2 start DC brake

F6.05	Acc./Dec. mode	
	0~1	0

0: linear Acc./Dec. mode

The output frequency increase or decrease in a constant slope, as showed in the following figure. 1: S curve Acc./Dec. mode

The output frequency increase or decrease in S type curve along with time. During the accelerating start and speed reaching period, and decrease start and decreasing reaching period, set the speed as S curve. Thus the increasing and decreasing action become smooth and the impact to load is decreased. The S curve Acc./Dec. is suitable for carry or deliver the start and stop of load, like elevator, conveyor, etc. As showed in the following figure: t_1 is accelerating time, t_2 is decreasing time, t_s is time of S curve initial segment, t_e is time of S curve end segment, $F6.06=ts/t_1$, $F6.07=te/t_2$

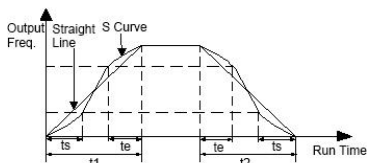

Fig. F6-3 Straight Line and S Curve of Acc./Dec.

F6.06	Time ratio of initial segment in S curve	10.0~50.0%	20.0%
F6.07	Time ratio of end segment in S curve	10.0~50.0%	20.0%

Details described in S curve Acc./Dec. item of F6.05.

F1.08	Stop mode	0~1	0
-------	-----------	-----	---

0: accelerating stop

When receiving stop command, the VFD decreases output frequency gradually according to decelerating time until zero and then stop. If stop DC brake function is valid, after reaching the stop DC brake initial frequency (according to F1.09 set, it may takes a period of stop DC brake waiting time), the VFD will conduct DC brake process and then stop.

1: free stop

Upon receiving the stop command, the VFD stops immediately, and the load stops according to mechanical inertia.

F6.09	Frequency threshold of DC brake	0.00~【F0.11】 upper limit freq.	0.00
F6.10	DC brake delay time	0.0~100.0s	0.0
F1.11	DC brake current	0.0~150.0%*rated current of motor	0.0%
F1.12	DC brake time at stop	0.0:DC brake no action 0.1~100.0s	0.0

The setting value of stop DC brake current is the percentage relative to rated current value of VFD. When stop brake time is 0.0s, there would be no DC brake process.

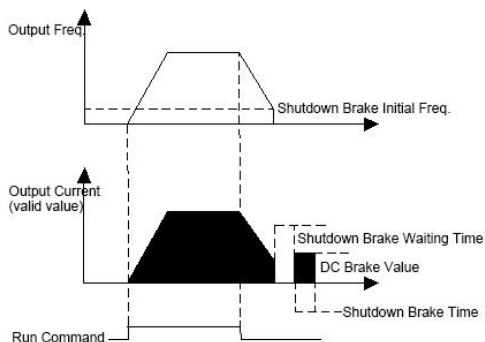

Fig. F6-4 Stop DC Braking

F7 Group – Panel Function Setting and Parameter Management

F7.00	Key M-FUNC function	
	0~4	0

0: JOG (jog control)

M-FUNC key is for jog control, and the default direction is set by F0.21.

1: FWD/REV switch

M-FUNC equals direction switch key in running status, and is disabled in stop status. This switching is only effective to command giving method of keypad.

2: clear frequency set by UP/DOWN key.

F7.01	Key STOP/RST function	
	0~3	3

0: only effective to panel control

Only when F0.02=0, this key can control the driver to stop.

1: effective to both panel and terminal control

Only when F0.02=0 or 1, can this key control the driver to stop. In the communication control mode, this key is invalid.

2: effective to both panel and communication control

Only when F0.02=0 or 2, can this key control the driver to stop. In terminal control mode, this key is invalid.

3: effective to all control modes

This key can control the driver to stop in all control modes.

Notice:

In all command giving methods, reset function is enabled.

F7.02	STOP+ RUN emergency stop	
	0~1	1

0: disabled

1: coast to stop

Press RUN and STOP/ RESET, the driver will coast to stop.

F7.03	Close-loop display factor	
	0.01~100.00	1.00

This function code is used to calibrate the error between the actual parameters (pressure, flow rate, etc.) and preset or feedback parameters (voltage, current). It has no effect on close-loop regulation.

F7.04	Rotating speed display factor	
	0.01~100.00	1.00

This function code is used to calibrate the error of rotating speed display. It has no effect on the actual speed.

F7.05	Line speed factor	
	0.01~100.00	1.00

This function is used to calibrate the error of line speed display. It has no effect on the actual speed.

F7.06	Encoder regulation speed	
	1~100	70

F7.07	Monitoring parameters selection 1 in operation status	
	0~57	0

F7.08	Monitoring parameters selection 2 in operation status	
	0~57	5

The items of main monitoring interface can be changed by modifying the set value of the above function codes. For example: set F7.07=5, then output current d-05 is selected, and the monitoring interface will display the present output current as default during operation.

F7.09	Monitoring parameters selection 1 in stop status	
	0~57	1

F7.10	Monitoring parameters selection 2 in stop status	
	0~57	12

The items of main monitoring interface can be changed by modifying the set value of the above function codes. For example:set F7.09=5, then output current d-06 is selected, and the monitoring interface will display the present output voltage as default during stop status.

F7.11	Parameter display mode	
	00~11	00

LED one's place: function parameters display mode

0: display all function parameters

1: only display parameters different from default value.

2: only display parameters modified after power on of the last time (reserved).

LED ten's place: monitoring parameters display mode

0: only display main monitoring parameters

1: alternate display of main and auxiliary parameters (interval time 1s)

LED hundred's place and thousand's place: reserved

F7.12	Parameter initialization	
	0~3	0

0: disabled

The driver is in normal read and write status. Whether the setting value of function codes can be modified is relevant to the setting of user password and present operation status.

1: restore to factory defaults (all user parameters except motor parameters)

All user parameters except motor parameters will be restored to factory defaults.

2: restore to factory defaults (all user parameters)

All user parameters will be restored to factory defaults. 3: clear fault record

Clear the contents of fault record D-48~D-57. After this operation, this function code will clear to 0 automatically.

F7.13	write-protect	
	0~2	0

0: allow all parameters to be modified (some are not during operation)

1: only allow F0.6, F0.7 and FE.14 to be modified

2: only allow PE.14 to be modified

F7.14	Parameter copy function	
	0~3	0

0: disabled

1: parameters upload to operation panel

If it is set at 1 and confirmed, the driver will display CP-1, and upload all function code parameters from control panel to EEPROM in operation panel for storage.

2: all function code parameters download to the driver

If it is set at 2 and confirmed, the driver will display CP-2, and download all function code parameters from operation panel except factory parameter to memory in main control panel, and refresh EEPROM.

3: download all function code parameters except motor parameters to the driver

If it is set at 3 and confirmed, the keypad will display CP-3, and the driver will download all function code parameters (except motor parameters and factory parameters) from operation panel to memory in main control panel, and refresh EEPROM

FE.00	LCD language option (LCD)	
	0~2	0

0: Chinese

1: English 2: reserved

F8 Group - Auxiliary function

F8.00	Accelerating time 2	
	0.1~3600.0	Depending on model
F8.01	Decelerating time 2	
	0.1~3600.0	Depending on model
F8.02	Accelerating time 3	
	0.1~3600.0	Depending on model
F8.03	Decelerating time 3	
	0.1~3600.0	Depending on model
F8.04	Accelerating time 4	
	0.1~3600.0	Depending on model
F8.05	Decelerating time 4	
	0.1~3600.0	Depending on model

There are four kinds of Acc/Dec time to be defined, make different combination of control terminals to choose acc/dec time 1~4 during VFD running, check F4.00~F4.06 for definition of acc/dec time terminal function.

Notice

Acc/Dec time 1 is defined in F0.14 and F0.15.

F8.06	Acc/Dec time unit	
	0~2	0

0: second, 1: minute, 2: 0.1s

This function code defines dimension of Acc/Dec time.

F8.07	Frequency setting of forward jog operation	
	0.00~ 【F0.16】 upper limit freq.	5.00
F8.08	Frequency setting of reverse jog operation	
	0.00~ 【F0.16】 upper limit freq.	5.00
F8.09	Jog Acc time	
	0.1~3600.0s	Depending on model
F8.103	Jog Dec time	
	0.1~3600.0s	Depending on model
F8.11	jog interval time	
	0.1~100.0s	0.1

F8.07~F8.11 defines relevant parameters of jog running. As showed in figure F8-1, t1 and t3 are accelerating time and decelerating time respectively of actual running; t2 is jog time; t4 is jog interval time (F8.11); f1 is forward jog running frequency (F1.20); f2 is reverse jog running frequency (F8.08). The jog accelerating time of actual running t1 is determined by the following formula:

$$t1 = F8.07 * F8.09 / F0.10$$

The jog decelerating time of actual running t3 is defined as follows: $t3 = F8.08 * F8.10 / F0.10$
 F0.10 is the maximum output frequency.

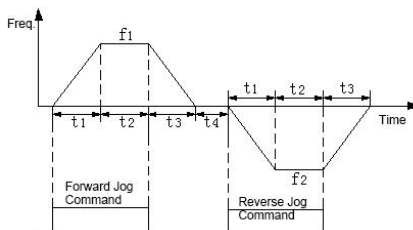

Fig. F8-1 Jog Run

F8.12	Hopping freq. 1	
	0.00~upper limit freq.	0.00
F8.13	Hopping frequency 1 range	
	0.00~upper limit freq.	0.00
F8.14	Hopping freq. 2	
	0.00~upper limit freq.	0.00
F8.15	Hopping freq. 2 range	
	0.00~upper limit freq.	0.00
F8.16	Hopping freq. 3	
	0.00~upper limit freq.	0.00
F8.17	Hopping freq. 3 range	
	0.00~upper limit freq.	0.00

These above function codes are used to keep the output frequency of VFD away from resonance frequency of mechanical load. The set frequency of VFD can be specified in a jumping mode around some frequency point as showed in the following figure, which means the VFD frequency will never stay in hopping frequency range, but the decelerating process will pass this range.

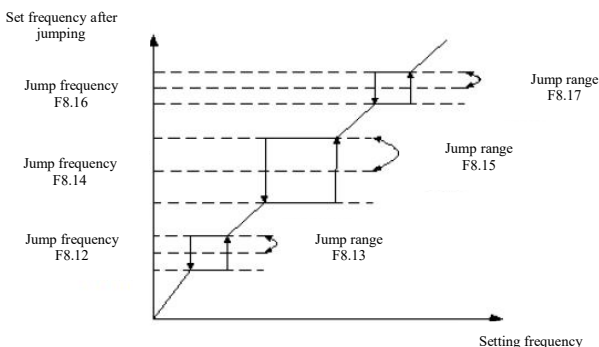

Fig. F8-2 Hopping Frequency

F8.18	Action when set freq. is lower than lower limit freq.	
	0~2	0

0: run at lower limit frequency

VFD runs at lower limit frequency when set frequency is lower than lower limit frequency setting value (F0.12).

1: run at zero frequency after delay time

When set frequency is lower than lower limit (F0.12), after delay time (F8.19), the VFD will run at zero frequency.

2: stop running after delay time

When set frequency is lower than lower limit (F0.12), after delay time (F8.19), the VFD will stop running.

F8.19	Delay time of stopping when frequency is lower than lower limit	
	0.0~3600.0s	10.0

For details check F8.18 parameter description.

F8.20	zero frequency brake current	
	0.0~150.0%	0.0

This parameter is the percentage of rated current of motor.

F8.21	FWD/REV transition time	
	0.0~100.0s	0.0

The waiting time VFD transit from forward running to reverse running or the other way around is as t1 showed in the following figure. It is also related to F8.22 setting.

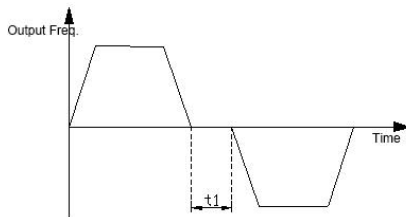

Fig. F1-7 FWD/REV run dead band time

F8.22	FWD/REV switch mode	
	0~1	0

0: over zero frequency switch

1: over start frequency switch

F8.23	emergency stop standby deceleration time	
	0.1~3600.0S	1.0

For details check NO.10 item function description of discrete input terminal (F4.00~F4.06).

F8.24	Stopping current, direct current, braking current, maintaining	
	0.0~100.0S	1.0

F8.25	Frequency arrival of FAR detection range	
	0.0~100.0%* 【F0.10】 max. freq.	100.0%

This function is supplementary instruction to NO.6 function of F5.00 ~ F5.03. When output frequency of VFD is within the detection range of setting frequency, the terminal output effective signal (open collector signal, low lever after pulling up of resistance). As showed in the following figure.

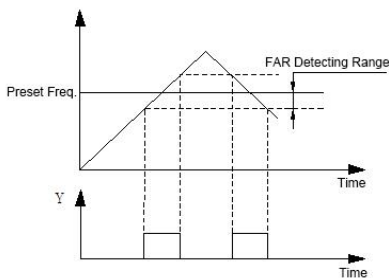

Fig. F8-4 Frequency Arrival

F8.26	FDT1 detection mode	
	0~1	0

0: speed preset value

1: speed detection value

F8.27	FDT1 level setting	
	0.00Hz~ 【F0.11】 upper limit Freq.	50.00

F8.28	FDT1 lag	
	0.0~100.0%* 【F8.27】	2.0%

F8.29	FDT2 detection mode	
	0~1	0

0: speed preset value

1: speed detection value

F8.30	FDT2 level setting	
	0.00Hz~ 【F0.16】 upper limit Freq.	25.00
F8.31	FDT2 lag	
	0.0~100.0%* 【F8.30】	4.0%

These above function codes (F8.26~F8.31) are supplementary instruction to NO.4, 5 function of function codes F7.00~F5.03. When output frequency of VFD exceeds preset value of PDF level, the effective signal is output (open collector signal, low level after pulling up of resistance); when output frequency decrease to lower than FDT signal (preset value - lag value), invalid signal is output(high impedance). As showed in the following figure.

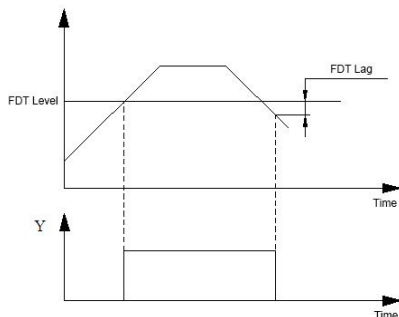

Fig. F8-5 Frequency Level Detecting

F9 Group Protection Parameter

FA.00	Motor overload protection	
	0~2	1

0: disabled

Without overload protection (use with caution)。

1: common motor (thermal relay, low speed compensation)

Since cooling conditions of common motor deteriorates at low speed, the motors thermal protection threshold should also be adjusted. The “low speed” here refers to the operating frequency lower than 30Hz, with which the motor will be lowered of the overload protection threshold.

2: variable frequency motor (thermal relay, without low speed compensation)

The cooling effect of variable frequency motor is not affected by the motors speed, so low speed compensation is not necessary.

FA.01	Motor overload protection factor	
	20.0%~120.0%	100.0%

In order to apply effective overload protection to different kinds of motors, the motor overload protection factor should be correctly set to limit the Max.output current of the driver. The factor is the percentage of motor rated current to the rated output current of the driver.

When the motor’s power level matches the driver, the protection factor can be set to 100%, as showed in Fig. F9-1

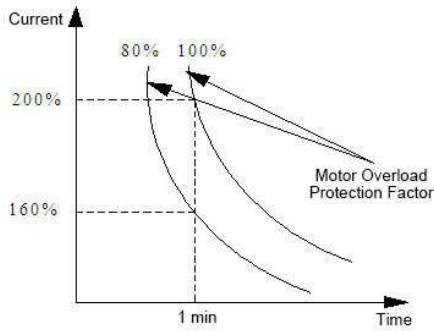

Fig. F9-1 Motor Overload Protection Factor

When the power of VFD is larger than the motor, in order to apply effective overload protection to motors with different specification, the factor should be set correctly as showed in Fig.F9-2

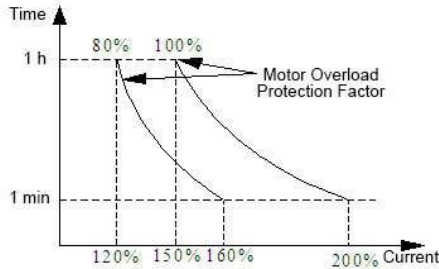

Fig. F9-2 Motor Overload Protection Factor Setting

The factor is calculated by the formula below:

$$\text{Motor overload Protection coefficient} = \frac{\text{allowed max. load current}}{\text{inverter's rated output current}} \times 100\%$$

Generally, the max. load current is the motors rated current.

F9.02	Undervoltage protection action	
	0~1	0

0: disabled

1: allowed (under voltage is seen as fault)

F9.03	Undervoltage protection level	
	220V: 180~280V	200V
	380V: 330~480V	350V
		Depending on model

This function code specifies the lower limit of DC bus voltage when the driver operates normally

Notice:

When the network voltage is low, the output torque of motor will decrease. In conditions of constant power load and constant torque load, the low network voltage will increase the input an output current of VFD, so as to lower the reliability of VFD operation. Therefore the VFD need to run in derated capacity when the network voltage is quite low for long term.

F9.04	Overvoltage limit level	
	220V: 350~390V	370V
	380V: 550~780V	660V
		Depending on model

This parameter defines the action voltage of stall overvoltage protection.

F9.05	voltage limit factor in decelerating	
	0~100	0: overvoltage stall protection nvalid Depending on model

During decelerating, the larger of this value, the stronger of the overvoltage suppressing ability.

F9.06	Current limit threshold (only valid in V/F mode)	
	G type: 80%~200%*VFD rated current	160% Depending on model
	P type: 80%~200%*VFD rated current	120%

This parameter defines auto current limiting threshold, and the set value is the percentage relative to the rated current of VFD.

Notice:

In the normal VF mode, F9.06 is used for amplitude limiting during accelerating or constant speed running; in Vector VF mode, F9.06 is used for amplitude limiting during accelerating, and no such limit process during constant speed running; in vector mode, the amplitude limit during constant speed running is only related to F2.20~F2.21.

F9.07	current limiting in field weakening region	
	0~1	0

0: limited by current limiting threshold of F9.06.

When output frequency is within 50Hz, F9.06 is used for amplitude limiting.

1: limited based on corrected current from F9.06

When output frequency is above 50Hz, amplitude limiting is processed based on corrected current from F9.06.

F9.08	Current limit factor in accelerating	
	0~100	0: current limit of accelerating invalid Depending on model

During accelerating, the larger of this value, the stronger of the overcurrent suppressing ability.

F9.09	Current limit in constant speed running	
	0~1	1

0: disabled, 1: enabled

F9.10	Off load detection time	
	0.1s~60.0s	5.0

F9.11	Off load detection level	
	0.0~100.0%*rated current of VFD	0.0%

0: off load detection disabled

Off load detection level (F9.10) defines the current threshold of off load action, and the set value is the percentage relative to rated current of the VFD.

Off load time (F9.10) defines the lasting time that the driver output current is lower than off load detection level (F9.11) continuously, after which the off load signal is sent.

Off load status valid means that the operating current of the driver is lower than off load detection level and the lasting time exceeds off load detection time.

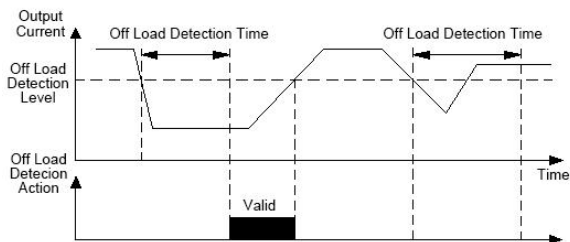

Fig. F9-3 Off Load Detection

F9.12	Overload pre-alarm level	
	G type: 20%~200%*VFD rated current	160% Depending on model
	P type: 20%~200%*VFD rated current	120%

Overload pre-alarm function is mainly used for monitoring overload condition before overload protection action. Overload pre-alarm level defines the current threshold of overload pre-alarm action, and the set value is the percentage relative to the rated current of VFD.

F9.13	Overload pre-alarm delay	
	0.0~30.0s	10.0

This parameter defines the delay time from the time when the output current of VFD is higher than the overload pre-alarm level (F9.12) to the time when overload pre-alarm signal is sent

Notice:

With the setting of parameter F9.12 and F9.13, when the output current of the driver is higher than overload pre-alarm level (F9.12), the driver will send pre-alarm signal after delay time (F9.13), i.e. the control panel will display “A-09”.

F9.14	Temperature detection threshold	
	0.0℃~90.0℃	65.0℃

For details see function description NO.51 of F5.00~F5.03.

F9.15	Phase loss protection of input/output	
	0~3	Depending on model

0: both invalid

1: invalid for input, valid for output 2: valid for input, invalid for output 3: both valid

Factory default 1 for VFD under 7.5kW, factory default 3 for VFD above 11kW.

F9.16	Delay time of input phase loss protection	
	0.0s~30.0s	1.0

When input phase loss protection is valid, and input phase loss fault occurs, protection action “E-12” will be enabled after a period of time defined by F9.16, and the driver will coast to stop.

F9.17	Detection reference of output phase loss protection	
	0%~100%*rated current of VFD	50%

When the VFD actual output current is higher than rated current * 【F9.17】 , if output phase loss protection is valid, action E-13 will be enable after delay time of 5s and the driver will coast to stop

F9.18	Detection factor of output current imbalance	
	1.00~10.00	1.00

If the ratio of the maximum value and minimum value of three phase output current is larger than this factor and last for over 10 seconds, the driver will display output current imbalance fault E-13. When F9.08=1.00, output current imbalance detection is invalid.

F9.19	reserved	
	reserved	0
F9.20	PID feedback disconnection processing	
	0~3	0

0: no action

1: alarm and run at frequency of disconnection moment 2: protection action and coast to stop

3: alarm and decelerate to zero-speed running according to set mode

F9.21	Feedback disconnection detection value	
	0.0~100.0%	0.0%

The maximum value of PID input works as the upper limit of feedback disconnection detection value. Within the time of feedback disconnection detection, when PID feedback is lower than feedback disconnection detection value continuously, the driver will respond with corresponding protection action.

F9.22	Feedback disconnection detection time	
	0.0~3600.0s	10.0

The lasting time before protection action after feedback connection happened

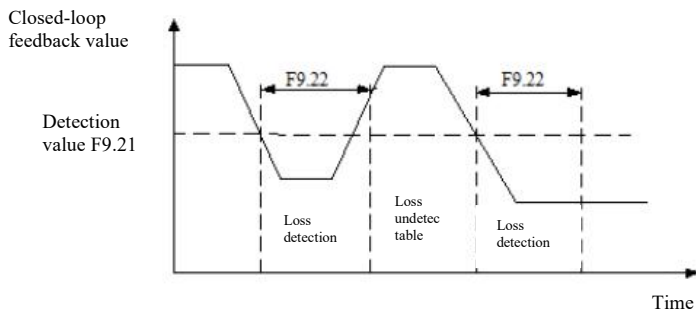

Fig. F9-4 Closed Loop Feedback Loss Detection

F9.23	reserved	
	reserved	0
F9.24	Action of RS485 communication error	
	0~2	1

0: protection action and coast to stop

1: alarm and maintain current operation 2: alarm and stop according to set mode

F9.25	RS485 communication timeout detect	
	0.0~100.0s	5.0

If RS485 didn't receive the right data signal within the defined time by this parameter, the RS 485 communication error is confirmed and the driver will respond with corresponding action based on F9.24 setting. The RS485 communication timeout detection will be disabled if this parameter is set at 0.0.

F9.26	Action of operation panel communication error	
	0~2	1

0: protection action and coast to stop

1: protection action and maintain the current operation 2: protection action and stop according to set mode

F9.27	Operation panel communication timeout detect	
	0.0~100.0s	1.0

If keypad communication didn't receive the right data signal during the time defined by this parameter, then keypad communication error is confirmed and the driver will respond with corresponding action based on F9.26 setting.

F9.28	EEPROM read-write error action	
	0~1	0

0: protection action and coast to stop, 1: alarm and keep on running

F9.29	Output ground protection when power on (reserved)	
	0~1	0

0: invalid, 1: valid

F9.30	Over speed protection action (reserved)	
	0~2	2

0: protection action and coast to stop

1: alarm and decelerate to stop

2: alarm and keep on running

F9.31	Overspeed detection value	
	0.0~50.0%*【F0.10】 max. freq.	0.0%

F0.32	Overspeed detection time	
	0.0~100.0s	5.0

FA.33	Action of big speed deviation (reserved)	
	0~2	0

0: protection action and coast to stop

1: alarm and decelerate to stop

2: alarm and keep on running

F9.34	Detection value of too large speed deviation (reserved)	
	0.0~50.0%*【F0.10】 max. freq.	0.0%
F9.35	Detection time of too large speed deviation (reserved)	
	0.0~100.0s	0.5

FA Group – PID Control Parameters

An integrated analog feedback control system can be formed through this group of parameters setting.

Analog feedback control system: specified value is input via AI1, the physical quantity of controlled object is converted to current of 4~20mA and input via AI2, then pass through built-in PI regulator, which form closed loop control system, as showed in the following figure:

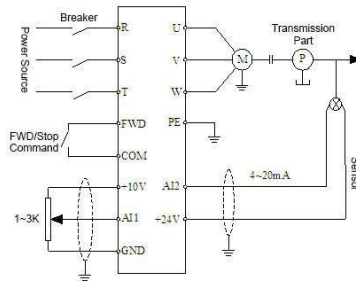
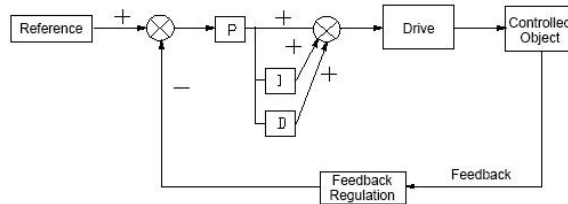

Fig. FA-1 Analog Feedback Control System

PID regulation is as follows:



FA.00	PID operation input mode	
	0~1	0

0: auto

1: manually input via defined multi-function terminal

FA.01	PID input channel	
	0~4	0

0: digital setting

PID input is given by digital setting, and determined by FA.02.

1: AI1

PID input is given by external analog signal AI1 (0~10V/0-20mA).

2: AI2

PID input is given by external analog signal AI2 (0~10V).

3: pulse setting

PID input is given by external impulse signal.

4: RS485 communication

PID input is given by communication.

	Digital reference input	
--	-------------------------	--

	0.0~100.0%	50.0%
--	------------	-------

This function realized input setting of closed loop control via keypad when analog feedback is used. It is only effective when digital setting of closed loop setting channel is selected (FA.01=0).

For example: in closed loop control system of constant pressure water supply, this function code setting should take into full account of measuring range of transmissible pressure gauge and its feedback signal output. If the measuring range is 0~10Mpa, the corresponding voltage output is 0~10V, then we need pressure of 6MPa, and set the digital value as 6.00V, so the needed pressure is 6MPa when PID regulation is steady.

FA.03	PID feedback channel	
	0~7	0

0: AI1

PID feedback is given by external analog signal AI1.

1: AI2

PID feedback is given by external analog signal AI2.

2: AI1+AI2

PID feedback is given by AI1 and AI2.

3: AI1-AI2

PID feedback is determined by difference of AI1 and AI2. When the difference is negative, the feedback value is 0.

4: MAX {AI1, AI2}

5: MIN {AI1, AI2}

6: pulse setting 7: RS485 communication

FA.04	PID controller advanced setting	
	0000~1001	000

LED one's place: PID regulation characteristic

0: positive logic

Positive logic is defined as that when feedback signal is smaller than PID input, the driver output frequency should be decreased (decrease feedback signal) so as to maintain the balance of PID. Examples are like tension control of winding, constant pressure water supply control, etc.

1: negative logic

Negative logic is defined as that when feedback signal is larger than PID input, the driver output frequency should be increased (decrease feedback signal) so as to maintain the balance of PID. Examples are like tension control of unwinding, central air-conditioning control, etc.

LED ten's place: proportion regulation characteristic (reserved)

0: integral regulation of constant proportion

1: integral regulation of automatically changing proportion

LED hundred's place: integral control characteristic

0: stop integral regulation when frequency arrives at upper/lower limit

1: continue integral regulation when frequency arrives at upper/lower limit

It is recommended to cancel continuing integral regulation for system requiring quick response.

LED thousand's place: reserved

FA.05	Proportional gain Kp	
	0.01~100.00s	1.00
FA.06	Integral time Ti	
	0.01~10.00s	0.10
FA.07	Derivative time Td	
	0.01~10.00s	0.00

0.00: no derivative regulation

Proportional gain (Kp):

It determines the adjusting strength of PID regulator. The larger of P, the larger of adjusting strength. But excessive adjusting strength will result in fluctuation easily. When feedback and reference shows deviation, regulating value that is in proportion to deviation is output. If the deviation is constant, the regulating value is constant. Proportion regulation can response quickly to the feedback changing, but can't realize floating control alone. The larger of the

proportional gain, the quicker of the regulating speed, which may result in fluctuation. The regulating method is as follows: set integral time a large value and derivative time zero, use proportion regulation alone to operate the system, check the steady deviation (offset) of feedback signal and reference when modifying the reference. If the offset is in the same direction of reference changing (for example, increase the reference, and the feedback value is always smaller than reference after the system became stable); otherwise, decrease proportional gain and repeat the process above until the offset reaching a quite small value.

Integral time (Ti):

It determines the speed of integral regulation.

When feedback shows deviation with reference, output regulation value increases continuously. If the deviation exists continuously, the regulation value will stay increasing until no deviation. The integral regulator can eliminate offset effectively, but being too strong can result in repeating overshoot and cause fluctuation to system. The adjustment of integral time parameter usually goes in descending order with observation of the effect at the same time until a steady speed fulfilling requirement is reached.

Derivative time (Td) :

It determines the adjustment intensity of deviation changing rate.

When the deviation is changing, regulation value in proportion to deviation changing rate is output. This regulation value is only relevant to the direction and value of deviation change, not of the deviation itself. Derivative regulation is processed according to variation trend when feedback signal is changing so as to suppress the change. Please be cautious to use it, because it will amplify interference of system easily, especially those whose changing frequency is relatively high.

FA.08	Sampling cycle T	
	0.01~100.00s	0.10

0.00: automatic

Sampling cycle corresponds to feedback. Regulator operates once in every sampling cycle. The longer of the cycle, the slower of the response, but the better of the suppress effect to interference signal. Normally no need to set this parameter

FA.09	Error limit	
	0.0~100.0%	0.0%

Error limit is the ratio of deviation (feedback and reference) absolute value to reference. PID regulator stops operation when feedback is within this range, as showed in the following figure. Setting this parameter correctly is helpful to improve the system stability, as frequent adjustment around target value can be avoided.

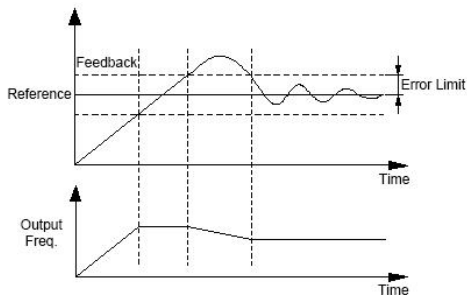

Fig. FA-3 Error Limit Schematic Diagram

FA.10	Closed loop preset freq.	
	0.00~upper limit freq.	0.00
FA.11	Preset freq. hold time	
	0.0~3600.0s	0.0

This function code defines the driver running frequency and time before PID control operates. In some control system, for a fast arrival of controlled object at preset value, these function codes can be set to force the driver to

output specific value of F8.10 and FA.11, which means operate the PID controller to increase response speed when controlled object is approaching the controlled target. As showed in the following figure

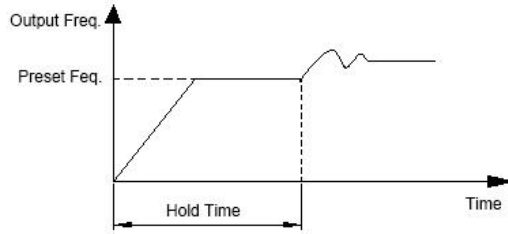

Fig. FA-4 Closed Loop Preset Frequency

FA.12	Sleep mode	
	0~2	1

0: invalid

1: dormant when feedback pressure exceed or lower than threshold value This is the first one of PID sleep mode, as showed in Fig. FA-5.

2: dormant when feedback pressure and output frequency is stable.

This is the second one of PID sleep mode, and it differs in the following two conditions (as showed in figure FA-6):

- 1) if feedback value is smaller than reference and larger than reference * (1 - set deviation 【FA.14】), and output frequency change rate is within 6%, the sleep mode is entered after delay time 【FA.17】 .
- 2) if feedback value increases to above reference value, the sleep mode is entered after delay time 【FA.17】 ; otherwise, if the feedback value decreases to under wake-up threshold 【F8.16】 , it will wake up immediately.

FA.13	Stop method of sleep mode	
	0~1	0

0: decelerate to stop, 1: coast to stop

FA.14	Deviation limit of feedback when entering sleep state compared with set pressure	
	0.0~20.0%	5.0%

This function parameter is only valid to the second sleep mode.

FA.15	Threshold value of sleep	
	0.00~200.0%	100.0%

This threshold value is the percentage of set pressure value. This parameter is only valid to the first sleep mode.

FA.16	Threshold value of wake-up	
	0.00~200.0%	90.0%

FA.15 defines the feedback value when the driver is entering sleep mode. If the actual feedback is larger than this set value, and the output frequency arrives at lower limit, the driver will enter sleep mode (zero speed operation) after delay time defined by FA.17.

FA.16 defines the feedback limit when the driver is entering operating state from sleep mode. When PID selects positive characteristic and the the actual feedback is smaller than this set value (or when PID selects negative characteristic and the actual feedback is larger than this set value), the driver will start to operate from sleep mode after delay time defined by FA.18.

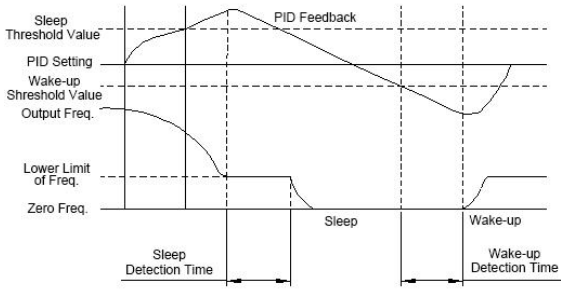

Fig. F8-5 the First Sleep Mode

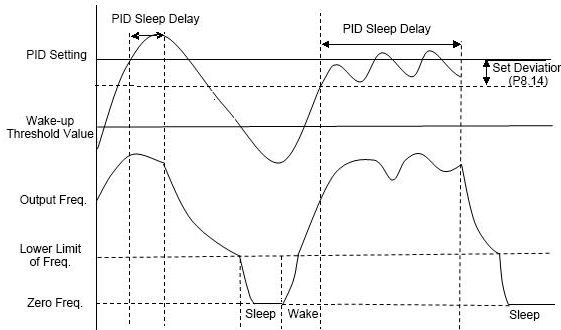

Fig. FA-6 the Second Sleep Mod

FA.17	delay time of sleep	
	0.0~6000.0s	100.0
FA.18	delay time of wake-up	
	0.0~6000.0s	5.0
FA.19	delay time of adding pump	
	0.0~3600.0s	10.0
FA.20	delay time of reducing pump	
	0.0~3600.0S	10.0

FA.19~FA.20 are delay time of adding and reducing pump in constant pressure water supply system, see function NO.31 and NO.32 in FA.21~FA.24.

FB Group-Traversal and Fixed Length Control

FB.00	Traversal control	
	0~1	0

0: disabled

1: enabled

FB.01	out method of traverse mode	
	0~1	0

0: auto

1: terminal config. (manually)

When FB.01 is set at 1, if multi-function terminal selects function NO.35, the driver will enter traverse mode.

Otherwise, traverse is enabled

FB.02	Amplitude control	
	0~1	0

0: fixed amplitude

The reference value of amplitude is max. frequency F0.10.

1: varied amplitude

The reference value of amplitude is specified channel frequency.

FB.03	restart method of traverse mode	
	0~1	0

0: start to the state before stop

1: just restart, no other requirement

FB.04	Save traverse state upon power failure	
	0~1	0

0: save, 1: not save

The traverse state parameters will be saved when poweroff. This function is only effective when “start to the state before stop” mode is selected.

FB.05	Preset traverse frequency	
	0.00Hz~upper limit	10.00
FB.06	Preset traverse frequency hold time	
	0.0~3600.0s	0.0

These above function codes defined run frequency before entering traverse mode or when exiting traverse mode and hold time of the frequency. If FB.61≠0, the driver will run at preset traverse frequency when start, and enter traverse mode after preset traverse frequency hold time.

FB.07	Traverse amplitude	
	0.0~100.0% (of reference freq.)	0.0%

Reference value of traverse amplitude is determined by FB.02. If FB.02=0, traverse amplitude

$AW = \text{max.frequency} * \text{FB.07}$; if FB.02=1, $AW = \text{reference} * \text{FB.07}$.

Notice

1:the traverse frequency is limited by upper and lower limit of frequency. Improper setting of the frequency limit will result in faults.

2:the traverse is invalid for jog or PID control mode.

F9.08	Step frequency	
	0.0~50.0% (of traverse amplitude)	0.0%

This function code indicates the falling amplitude after reaching upper limit of frequency, or the rising amplitude after reaching lower limit of frequency.

If it is set at 0.0%, then there will be no step frequency.

FB.09	Traverse rising time	
	0.1~3600.0s	5.0
FB.10	Traverse falling time	
	0.1~3600.0s	5.0

These above function codes defined the time rising from lower limit to upper limit of frequency and falling from upper limit to lower limit.

Traverse function applies to textile and chemical fiber industry, or others that requires lateral movement or rolling.

The typical application is shown in Fig. FB-1.

The driver accelerates to preset traverse frequency (FB.05) and stay at it for a period of time (FB.06). Next, it will arrive at central frequency within Acc time, and then it will operate according to traverse amplitude (FB.07), hopping frequency (FB.08), rise time (FB.09) and fall time (FB.10) one cycle after another until the stop command is received. It will then decelerate to stop within Dec time.

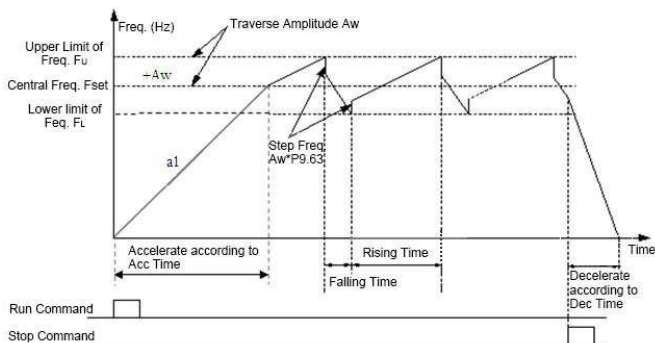

Fig.FB-1 Traverse Operation

Notice:

- 1: the central frequency is the frequency of digital setting, analog setting, impulse, PLC or MS running.
- 2: the traverse is invalid for jog or closed loop running.
- 3: when both PLC and traverse are enabled, the traverse is invalid when transferring to another PLC stage. The output frequency begins to traverse after arriving at the PLC preset frequency within Acc/Dec time. When receiving stop command, the driver will stop according to PLC Dec time.

FB.11	reserved	
	reserved	0
FB.12	Length control	
	0~1	0

0: disabled, 1: enabled

FB.13	Preset length	
	0.000~65.535(KM)	0.000
FB.14	Actual length	
	0.000~65.535(KM)	0.000
FB.15	Length factor	
	0.100~30.000	1.000
FB.16	Length calibration	
	0.001~1.000	1.000
FB.17	Shaft circumference	
	0.10~100.00CM	10.00
FB.18	Pulse per revolution (X6)	
	1~65535	1000

These above parameters are used for length control.

The counting pulse is input from terminal X6 defined as function NO.53. The length is calculated based on FB.18 and FB.17.

Calculated length=number of counting pulse÷number of pulse per revolution×shaft circumference

After correcting the calculated length by FB.15 and FB.16, the actual length is obtained

Actual length=calculated length×F9.70÷F9.71

When the actual length (FB.14) ≥ preset length (FB.13), the driver will stop automatically. You must clear the actual length record (FB.14) record or modify the setting of it to a value smaller than preset length (FB.13), or the driver cannot be started.

Notice:

The actual length can be cleared by multi-function input terminal (set the corresponding parameter at function NO.46) if the terminal is enabled. The actual length and pulse number can be calculated only after this terminal is disconnected.

Actual length (FB.14) will be saved automatically after power off.

Function of stop at fixed length is disabled if FB.13 is set to 0, but the calculated length is still effective. Application of stop at fixed length:

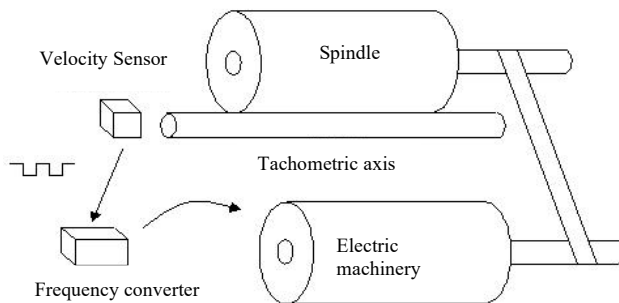

Fig. FB-2Application of Stop at Fixed Length

In Fig.FB-2, the driver drives the motor, and the motor, in turn, drives the spindle through the belt. The shaft that contact with the spindle can measure the line speed of it which will be transmit to the drive by the sensor in the form of pulse. The driver will calculate the length based on the number of pulses it received. When the actual length \geq preset length, the driver will give stop command automatically to stop the spinning.

FB.19	counting value arrival processing	
	0~3	3

- 0: stop counting, stop output
- 1: stop counting, continue output
- 2: cycle output, stop output
- 3: cycle output, continue output

The driver executes the according action when counting value arrives at preset value of FB.21.

FB.20	Counting start condition	
	0~1	1

- 0: start during power on
- 1: start in running status, stop in stop status

These above is based on premise of counting impulse.

FB.21	Counter reset value	
	【F7.33】 ~65535	0
FB.22	Counter detection value	
	0 ~ 【FB.21】	0

This function code defines counting reset value and detection value of counter. When the counting value arrives at the preset value of FB.21, the corresponding multi-function output terminal will send out valid signal and the counter will be cleared to zero.

When the counting value reaches the preset value of FB.22, the corresponding output terminal (output signal of counter detection) sends out valid signal. If the counting continues and exceeds the preset value of FB.21, this output signal will be revoked when the counter is cleared.

As showed in the following figure: the programmable relay output is set as reset signal output, open collector output Y1 is set as counter detection output, FB.21 is set as 8, FB.22 is set as 5. When the detection value is 5, Y1 output valid signal and maintain it; when detection value arriving at reset value 8, the relay output valid signal of one cycle impulse and the counter is cleared, meanwhile, Y1 and relay will revoke output signal.

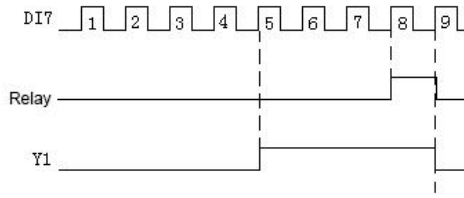

Fig. FB-3 Counter Reset and Detection Setting

FB.23	Time out processing	
	0~3	3

- 0: stop timing, stop output
- 1: stop timing, continue output
- 2: cycle timing, stop output
- 3: cycle timing, continue output

This action is executed when the counting value arrives at preset value of FB.25.

FB.24	Timing start condition	
	0~1	1

- 0: start during power on
- 1: start in running status, stop in stop status.

FB.25	Timing setting	
	0~65535s	0

FC Group Programmable Operation Parameter

FC.00	PLC running mode	
	0~3	0

- 0: stop after a single cycle

As Fig.FC-1 shows, the driver stops after a single cycle. It will start given another command. If operation time is 0 in some segment, the

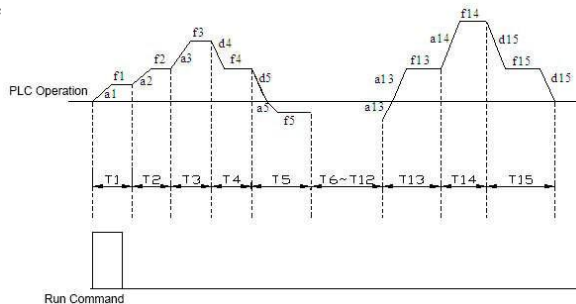

Fig. FC-1 Stop after a Single PLC Cycle

- 1: maintain value of the last stage after single cycle

As Fig.FC-2 shows, the driver holds the frequency and direction of the last stage after single cycle.

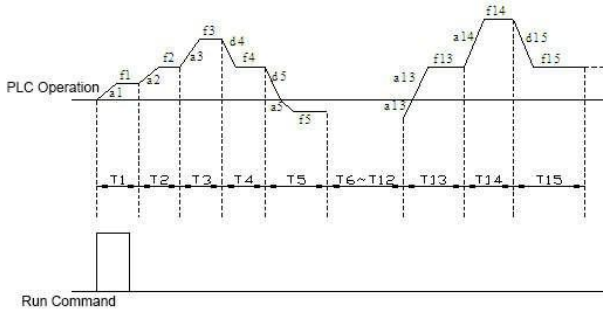

Fig.FC-2 Maintain Last Stage after Single Cycle

2: continuous cycle of limited times

The driver runs with cycle times set by FC.04, and stops after reaching of cycle times. If FC.04=0, the driver won't run.

3: continuous cycle

The driver continues running cycle after cycle until stop command is received, as showed in the following figure.

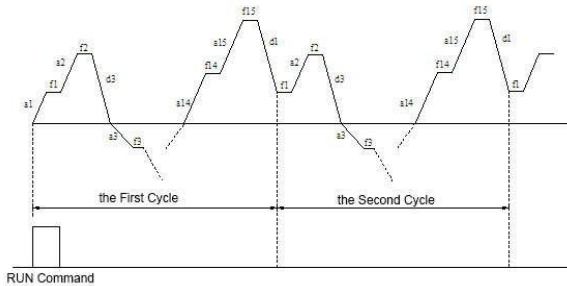

Fig.FC-3 PLC Continuous Cycle

FC.01	Input mode of PLC running	0
	0~1	

0: auto

1: manual input via multi-functional terminal

FC.02	PLC running state saving after poweroff	0
	0~1	

0: not save

The PLC state will not be saved when poweroff, and the driver will start from the first stage after powerup.

1: save

The PLC state including the stage, frequency and run time will be saved when poweroff. After powerup and receiving run command, the driver will run at the preset frequency of the stage for the remaining time of the stage.

FC.03	PLC restart mode	0
	0~2	

0: start from the first stage

The driver restarts from the first stage of PLC after interrupts, such as stop command, fault or poweroff.

1: continue from the stage where the driver stops

When the driver stops caused by stop command, fault or poweroff, it can record the time that it has undergone in the current stage. After restart, it will run at the preset frequency of the stage for the remaining time of the stage, as Fig. FC-4 shows.

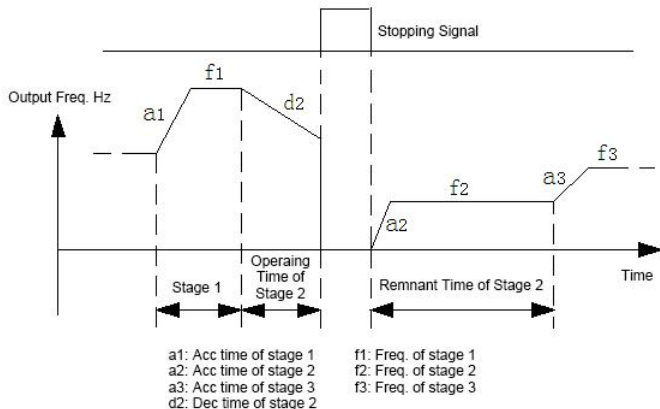

Fig. FC-4 PLC Start Mode 1

2: start from the frequency where it stops (fault)

When the driver stops caused by stop command, fault or poweroff, it can record both the time it has undergone in the current stage and the very frequency when the driver stops. After restart, it will pick up the recorded frequency and run for the remaining time of the stage. See Fig. FC-5.

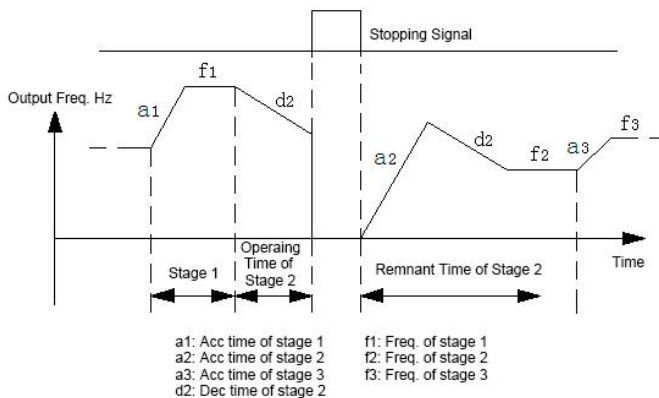

Fig.FC-5 PLC Start Mode 2

Notice

The difference between PLC start mode 1 and mode 2 is that in mode 2, the driver can record the operating frequency when the driver stops and continue to operate at the recorded frequency after restart.

FC.04	Limited times of continuous cycle	1
FC.05	Unit of PLC operating time	0

0: s, 1: m

FC.06	Multi-speed freq. 0	5.00
	-upper limit ~ upper limit	
FC.07	Multi-speed freq. 1	10.00
	-upper limit ~ upper limit	
	Multi-speed freq. 2	

FC.09	-upper limit ~ upper limit	15.00
	Multi-speed freq. 3	
FC.10	-upper limit ~ upper limit	20.00
	Multi-speed freq. 4	
FC.11	-upper limit ~ upper limit	25.00
	Multi-speed freq. 5	
FC.12	-upper limit ~ upper limit	30.00
	Multi-speed freq. 6	
FC.13	-upper limit ~ upper limit	40.00
	Multi-speed freq. 7	
FC.14	-upper limit ~ upper limit	50.00
	Multi-speed freq. 8	
FC.15	-upper limit ~ upper limit	0.00
	Multi-speed freq. 9	
FC.16	-upper limit ~ upper limit	0.00
	Multi-speed freq. 10	
FC.17	-upper limit ~ upper limit	0.00
	Multi-speed freq. 11	
FC.18	-upper limit ~ upper limit	0.00
	Multi-speed freq. 12	
FC.19	-upper limit ~ upper limit	0.00
	Multi-speed freq. 13	
FC.20	-upper limit ~ upper limit	0.00
	Multi-speed freq. 14	
FC.21	-upper limit ~ upper limit	0.00
	Multi-speed freq. 15	

The sign symbol of multi-speed frequency determines running direction, and minus means reverse running. Input mode of frequency is set by F0.03=6, and start and stop command is set by F0.02

FC.22	Acc/Dec time of MS stage 1	
	0~3	0
FC.23	Run time of MS stage 0	
	0.0~6553.5S(M)	0.0
FC.24	Acc/Dec time of MS stage 1	
	0~3	0
FC.25	Run time of MS stage 1	
	0.0~6553.5S(M)	0.0
FC.26	Acc/Dec time of MS stage 2	
	0~3	0
FC.27	Run time of MS stage 2	
	0.0~6553.5S(M)	0.0
FC.28	Acc/Dec time of MS stage 3	
	0~3	0
FC.29	Run time of MS stage 3	
	0.0~6553.5S(M)	0.0
FC.30	Acc/Dec time of MS stage 4	
	0~3	0
FC.31	Run time of MS stage 4	
	0.0~6553.5S(M)	0.0
FC.32	Acc/Dec time of MS stage 5	
	0~3	0

FC.33	Run time of MS stage 5	
	0.0~6553.5S(M)	0.0
FC.34	Acc/Dec time of MS stage 6	
	0~3	0
FC.35	Run time of MS stage 6	
	0.0~6553.5S(M)	0.0
FC.36	Acc/Dec time of MS stage 7	
	0~3	0
FC.37	Run time of MS stage 7	
	0.0~6553.5S(M)	0.0
FC.38	Acc/Dec time of MS stage 8	
	0~3	0
FC.39	Run time of MS stage 8	
	0.0~6553.5S(M)	0.0
FC.40	Acc/Dec time of MS stage 9	
	0~3	0
FC.41	Run time of MS stage 9	
	0.0~6553.5S(M)	0.0
FC.42	Acc/Dec time of MS stage 10	
	0~3	0
FC.43	Run time of MS stage 10	
	0.0~6553.5S(M)	0.0
FC.44	Acc/Dec time of MS stage 11	
	0~3	0
FC.45	Run time of MS stage 11	
	0.0~6553.5S(M)	0.0
FC.46	Acc/Dec time of MS stage 12	
	0~3	0
FC.47	Run time of MS stage 12	
	0.0~6553.5S(M)	0.0
FC.48	Acc/Dec time of MS stage 13	
	0~3	0
FC.49	Run time of MS stage 13	
	0.0~6553.5S(M)	0.0
FC.50	Acc/Dec time of MS stage 14	
	0~3	0
FC.51	Run time of MS stage 14	
	0.0~6553.5S(M)	0.0
FC.52	Acc/Dec time of MS stage 15	
	0~3	0
FC.53	Run time of MS stage 15	
	0.0~6553.5S(M)	0.0

These above function codes are used to set Acc/Dec time and run time of multi-speed operation.

Acc/Dec time setting at 0 stands for Acc/Dec time 1 (F0.14~F0.15); Acc/Dec time setting at 1, 2, 3 stand for respectively Acc/Dec time 2 (F8.00~F8.01)、3(F8.02~F8.03)、4 (F8.04~F8.05) .

Run time of of these 16 stages are set by run time of stage X respectively (X:0~15).

Notice:

1: A stage is ineffective if its run time is set to 0.

2: The control of PLC process including input, pause and reset can be realized via terminal. See function definition of F4 terminal.

3: PLC operation direction is determined by plus/minus of frequency and operation command together. The running direction of motor can be changed by external command.

FC.54	reserved	
	reserved	0

Fd Group Communication Parameter

Fd.00	Communication protocol	
	0~1	0

Communication protocol selection

0: MODBUS. 1: user-defined

Fd.01	Local address	
	0~247	1

0: broadcasting address 1~247: slave station

During 485 communication, the parameter can identify local driver's address.

Notice

"0" is the broadcasting address. When it is set so, the slave can receive and execute the command by host, but will not answer back.

Fd.02	Baud rate setting	
	0~5	3

0: 2400BPS

1: 4800BPS

2: 9600BPS

3: 19200BPS

4: 38400BPS

5: 115200BPS

This function code is used to define the data transmission rate between host and VFD. The baud rate setting of host should be in accord with that of VFD, or the communication will go wrong. The larger of the baud rate, the quicker of the response, but too larger of the setting value may affect the communication stability.

Fd.03	Data format	
	0~5	0

0: no parity (N, 8, 1) for RTU

1: even parity (E, 8, 1) for RTU

2: odd parity (O, 8, 1) for RTU

3: no parity (N, 8, 2) for RTU

4: even parity (E, 8, 2) for RTU

5: odd parity (O, 8, 2) for RTU Notice: ASCII mode is reserved at present

The host should keep the same data format with the driver, or there will be fault for communication.

Fd.04	Response delay	
	0~200ms	5

Response delay refers to the time from the driver receiving the command of the host to returning reply frame to the host. If the response time is shorter than system processing time, go with the system processing time. Otherwise, the system will send data to host after delay waiting time.

Fd.05	Transmission response	
	0~1	0

0: response to write operation

The driver will response to all read-write commands of host.

1: not response to write operation

The driver will response to all read command of the host, but not to the write command, so as to improve communication efficiency.

Fd.06	Ratio correlation	
	0.01~10.00	1.00

This function code is used to set weight coefficient of frequency command received via RS485 when the driver is set as slave. The actual operation frequency is this parameter value multiplied by the command value received via RS485. In jointly control, this function code can set running frequency ratio of multiple VFD

Fd.07	Communication mode selection	
	0.01~10.00	1.00

0: Universal mode, 1: MD380 mode

FE Group Advance Function Parameter and Performance Parameter

FE.00	Dynamic braking	
	0~2	2

0: disabled, 1: enabled, 2: only enabled during decelerating

FE.01	Initial voltage of dynamic braking		Depending on model
	220V: 340~380V	360V	
FE.02	Hysteresis voltage of dynamic braking		Depending on model
	220V: 10~100V	5V	
FE.03	Action ratio of dynamic braking		100%
	10~100%		

These above function codes are used to set voltage threshold of the action, backlash voltage and usage rate of brake unit. If the internal DC side voltage is higher than the initial voltage of dynamic braking, the internal brake unit will act. If there is brake resistor connected, the pumping voltage energy will be released via the brake resistor to achieve drop of DC voltage. When the DC side voltage falls to a specific value (initial value - brake backlash), the internal brake unit will close.

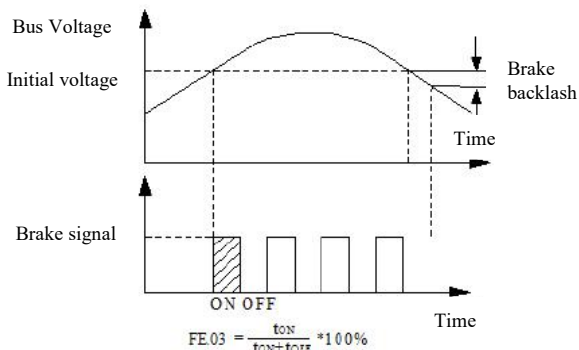

Fig. FE-1 Dynamic Braking

FE.04	Restart after power failure	
	0~2	0

0: disabled

The driver will not auto restart after power on.

1: start at start frequency

After power on, if start condition is met, the driver will auto start at start frequency after a period of time specified by FC.05.

2: start in speed tracking mode

After power on, if start condition is met, the driver will auto start in speed tracking mode after a period of time specified by FE.05.

FE.05	Restart delay after power failure	
	0.0~60.0s	5.0

In this delay time, any command input is invalid. If stop command is input, the driver will auto unlock speed tracking restart status and back to normal stop status.

Notice:

- 1: F9.02 needs to be set at 0 to ensure the restart after power off is valid.
 2: this parameter may cause unexpected start of motor and bring damage to equipment and people, be cautious to use it.

FE.06	Auto reset times	
	0~100	0
FE.07	Auto reset interval	
	0.1~60.0s	3.0

100: no times limit, i.e. infinite times

When fault occurs during operation, the driver will stop output and display fault codes. After a period of time specified by FE.07, the driver will auto reset and restart according to set start mode.

The auto reset times after fault occurring is specified by FE.06. When it is set at 0, auto restart function will be disabled and the driver can only be reset manually. When FE.06 is set at 100, there will be no limit for reset times. For IPM fault, external fault, etc., auto reset function of the driver is not allowed.

FE.08	Cooling fan control	
	0~1	0

0: auto control mode

1: operation all the way during power on

FE.09	Password of operation limit function	
	0~65535	0

By default, the password is 0, and FE.10 and FE.11 can be set; when there is a password, the setting of FE.10 and FE.11, should be after the password is verified right. The password can be set at 0 if there is no need for it. For this password setting, input five-digit number and press , the password will take into effect after one minute later. When there is a need to modify the password, choose FE.09 function code, press ENTER, to enter verification status. After successful authentication, enter modify status and input the new password, press ENTER , and the password is modified successfully. One minute later, the new password will take into effect automatically. For clear password, just set it at "00000".

FE.10	Operation limit function	
	0~1	0

0: disabled

1: enabled

During operation limit, as long as the total operation time exceeds the time specified by FE.11, the driver will respond with protection action and coast to stop, and the keypad displays E-26 (RUNLT). To clear this fault, just very FC.09 right and set FC.10 at "0"(disabled).

FE.11	Limit time	
	0~65535h	0

Note: this parameter can be reset, see description of FE.09.

FE.12	Freq. decreasing point of transient power failure		
	220V: 180V~330V	250V	Depending on model
	380V: 300V~550V	450V	

If the driver bus voltage decrease to lower than FE.12 * rated bus voltage, and the function of immunity to transient power failure is enabled, the corresponding action will start.

FE.13	Frequency decreasing factor of transient power failure	
	1~100 0: function disabled of immunity to transient power failure	0

FE.14	Droop control	
	0.00~10.00Hz	0.00

0.00: droop control function disabled When multiple drivers are driving the same one load, the speed difference will cause unbalance distribution of load, which will result in too much load to the driver with higher speed. The droop control is to make speed troop changing with the increase of the load, so as to equalizing load distribution. This parameter is to adjust frequency variation of frequency drooping driver. When F0.18=1 (high frequency mode), the upper limit of this parameter is 100.0Hz.

FE.15	delay time of rotating speed tracking	
	0.1~5.0s	1.0

The driver will start rotating speed tracking after this period of time.

FE.16	Current amplitude limiting of rotating speed tracking	
	80%~200%* rated current of VFD	Depending on model

This function code is used for auto current amplitude limit during rotating speed tracking. When actual current arrives at the threshold (FE.16), the driver will decrease frequency and limit current, then go on with tracking acceleration; the set value is the percentage related to rated current of the driver.

FE.17	Speed of rotating speed tracking	
	1~125	25

When rotating speed tracking starts, this parameter is used to determine the speed of tracking. The smaller of the value, the faster of the tracking. But too fast of the tracking may cause it unreliable.

FE.18	PWM mode	
	0000~1311	Depending on model

LED one's place: PWM synthesise method

0: seven segments of full band

Current output is stable, power tube of full band produces a large amount of heat.

1: switch form 7 segments to five segments

Current output is stable, heat production is large for power tube of low frequency, and small for that of high frequency.

LED ten's place: PWM temperature correlation

0: disabled, 1: enabled

If this function is enable, when the temperature of heat sink arrives at alarm value (50℃), the driver will decrease its carrier frequency automatically until the temperature back to lower than the alarm value.

LED hundred's place: PWM frequency correlation

0: disabled, 1: low frequency adjustment, high frequency adjustment

2: no adjustment for low frequency, high frequency adjustment 3: low frequency adjustment, no adjustment for high frequency, When PWM is correlated with temperature, and the temperature of heat sink arrives at alarm value (50℃), if low, frequency and high frequency are not adjusted, carrier frequency will remain unchanged; otherwise, the driver will decrease carrier frequency automatically.

LED thousand's place: flexible PWM function

0: disabled, 1: enabled

When this function is enabled, PWM method will be modified to reduce electromagnetic interference and motor noise.

FC.19	AVR function	
	0000~0112	0102

LED one's place: AVR function

0: disabled, 1: always enabled

2: disabled during decelerating

AVR means auto voltage regulation. When the input voltage of the driver deviates from its rated value, this function is used to maintain the output voltage constant to protect the motor from working in overvoltage status. This function is disabled when output command voltage is higher than input power voltage. If AVR is disabled during decelerating, the Dec time is shorter but the current is higher, other, the motor decelerates smoothly with lower current, but the Dec time is longer.

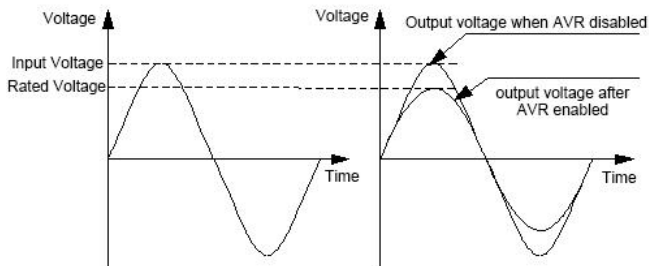

Fig. FE-2 AVR Function

LED ten's place: overmodulation

0: disabled, 1: enabled

Overmodulation function means that the driver will boost its bus voltage usage rate to increase output voltage. When it is enabled, the output harmonic component will increase. This function can be used when the driver works with a heavy load for a long time or high frequency (over 50Hz) operation torque is insufficient.

LED hundred's place: dead-time compensation

0: disabled, 1: enabled

If it is enabled, dead time compensation of all band will be conducted in all control modes. This function is mainly for manufacturer debugging, and not recommended to set by customers.

LED thousand's place: harmonic components optimizing (reserved)

0: disabled, 1: enabled

FE.20	Oscillation suppressing factor		
	0.00~300.00		0
FE.21	Flux braking		
	0~100		0

This parameter is used to adjust the flux braking ability during decelerating. The larger of the value, the stronger of the flux braking ability, and the shorter of the decelerating time. Normally there is no need to set it. This function is disabled if the parameter is set at 0.

When overvoltage limit level is low, this function can help reducing decelerating time. Otherwise there is no need to open this function.

FE.22	Energy saving control factor		
	0~100		0

The larger of the setting value, the better of the energy saving effect, but may cause unstable operation. This function is only valid for V/F control mode, and is disabled when set at 0.

FE.23	MS priority		
	0~1		0

0: disabled

1: MS prior to F0.03 setting.

FE.24	Jog priority		
	0~1		0

0: disEbled

1: the jog has the highest priority during the driver operation.

FE.25	Special function		
	0000~0001		1000

LED one's place: A02 and D0 output selection 0: A02 enabled

1: D0 enabled

LED ten's place: eserved

LED hundred's place: reserved LED thousand's palce: reserved

FE.29	User password	
	0~65535	0

User password setting function could prevent unauthorized person from checking and modifying the function parameters.

To avoid misoperation, user password less than 10 is invalid. When setting the user password, input a number not less than 10, press ENTER, to confirm, and the password will take into effect after one minute. To modify the password, choose F0.00 function code, and press ENTER, to enter password authentication status. After the authentication is successfully done, enter modifying status and input a new password, press ENTER, to confirm, and the modifying will be done successfully. New password will take into effect after 3 minutes.

Notice

Please keep the password carefully, and seek help from the manufacture once lost the password.

FE.301	Control software version	
	1.00~99.99	1.00
FE.31	Keypad software version	
	1.00~99.99	1.00
FE.32	VFD rated power	
	0.4~999.9KW (G/P)	Depending on model

The above function codes are used for indicating the relevant information of VFD, which can not be modified but only checked

7.Troubleshooting

7.1 Fault information and Troubleshooting

Any abnormality occurs during operation, the driver will lock PWM output immediately and enter protection status. Meanwhile, the keypad will display function codes indicating the current fault, and the ALM indicator light will be on. Follow the method described in Table 6-1 to check the fault cause and conduct according actions. If the problem remains, contact us directly.

Table 9-1 Fault Diagnosis and Troubleshooting

Fault code	Fault descriptions	Possible reasons	Actions
E-01	Over-current in Acc process	Too short Acc time (including tuning process)	Prolong the Acc time
		Restart the rotating motor	Start after setting as DC brake, or rotational speed tracking start
		Drive power is too small	Select a higher power drive
		V/F curve is not suitable	Adjust V/F curve or torque boost
E-02	Over-current in Dec process	Too short Dec time (including tuning process)	Prolong the Dec time
		Too low driver's power	Select the drive with large capacity
		the load inertia is too high	Connect suitable braking resistor or braking
E-03	Over-current in constant speed	Low network voltage	Check the power supply
		Sudden change or abnormal of load	Check the load or reduce the change of the load
		Too low driver's power	Select the driver with larger capacity
E-04	Over voltage in Acc process	Abnormal supply voltage (including tuning process)	Check the power supply
		The driver is restarted with a rotating motor	Start after setting as DC braking, or rotational
		Special potential energy load	Connect suitable braking resistor or braking
E-05	Over voltage in Dec process	Too short Dec time (including tuning process)	Prolong the Dec time
		The load inertia is too high	Connect suitable braking resistor or braking unit
		Abnormal of supply voltage	Check the power supply
E-06	Over voltage in constant-spee	Abnormal of supply voltage	Check the power supply
		Special potential energy load	Connect suitable braking resistor or braking
E-07	Bus undervoltage	Abnormal of supply voltage or disconnecting of contactor	Check supply voltage or seek help from manufacturer
E-08	Motor overload	Improper setting of V/F curve or torque boost	Adjust V/F curve and torque boost value
		Low network voltage	Check network voltage
		Motor blocked or load sudden	Check load

		change	
		Incorrect setting of motor overload protection factor	Correct the setting
E-09	Driver overload	Improper setting of V/F curve or torque boost	Adjust V/F curve and torque boost value
		Low network voltage	Check network voltage
		Too short Acc time	Prolong Acc time
		Too heavy load	Select the driver with larger power
E-10	Off load	Output current lower than off-load detection	Check load
E-11	Function module fault	Short circuit or grounded of driver output	Check motor wiring
		Instantaneous over current of	Refer to actions of over current
		Obstruction of damage of control board abnormal or	Clear the ventilation channel or replace the fan
		Power device damage	Seek help from manufacturer
E-12	Input phase loss	Phase loss of power supply	Check power supply and wiring
E-13	Output phase loss or current imbalance	Output phase failure among phase U, V, W	Check the driver's output wiring
E-14	Short trouble of output to ground	reserved	reserved
E-15	Heatsink overheat 1	Ambient over-temperature	Lower the ambient temperature
E-16		Fan damage	Replace the fan
	Heatsink overheat 2	Obstruction of ventilation	Clear the ventilation channel
E-17	RS485 communication failure	Mismatching with baud rate of host PC	Adjust the baud rate
		RS485 channel interference	Check whether the communication wiring is shield, whether the wiring is correct; consider connecting filter capacitor if necessary
		Communication timeout	retry
E-18	Keypad communication	Connecting line between keypad and control board is	Replace the connecting line.
E-19	External device fault	Input terminal of external device fault is closed	Disconnect the terminal and clear the faults (check the fault cause)
E-20	Current detection fault	Hall device or amplification circuit	Seek help from manufacturer
		Auxiliary power supply is	
		Hall or power board wiring is bad contact	
E-21	Motor tuning fault	Wrong setting of motor	Reset the motor parameter
		Mismatching of power specification between driver and motor	Seek help from manufacturer
		Tuning timeout	Check motor wiring
E-22	EEPROM R/W fault	EEPROM fault	Seek help from manufacturer
E-23	Parameter copy fault	Upload fault of the driver parameter to	Check wiring of operation panel
		Download fault of parameter	Check wiring of operation panel

		operation panel to the driver	
		Parameter download without upload in advance	Upload parameters first, then download
E-24	PID feedback disconnectin	PID feedback wire is loosen	Check feedback wiring
		Feedback value lower than disconnection detection value	Adjust detection input threshold
E-25	Voltage feedback	Feedback value lower than disconnection	Adjust detection input threshold
E-26	Arrival of operation limit	Arrival of operation limit time	Seek help from agent
E-27	Co-processor communication	reserved	reserved
E-28	Encoder disconnecting	reserved	reserved
E-29	Large deviation of speed	reserved	reserved
E-30	Overspeed fault	reserved	reserved

7.2 Abnormal Phenomena Solution

During the driver operation, the common abnormal phenomena and solving actions are as showed in Table 6-2.

Table 6-2 Common Abnormal Phenomena and Counteractions

Phenomena		Possible reasons of fault and actions to take
motor not running	LED no display	Check whether there is power failure, or phase loss of input power, check if the
	LED no display, but the internal charging indicator is on	Check if there is problems with wiring or socket related to keypad. Measure the voltage of internal control source to check if the switching power supply is functioning well. If not, check its inlet wire, start oscillation and stabilivolt to see if they works well.
	Motor droning	The motor load is too much. Reduce the load.
	No abnormal phenomena	Check if it is in trip status or hasn't reset after tripping, check whether it is in restart status after power down, whether the keypad is reset, whether it is in program running status, multi-speed operation status, some specific operation status or non-operation status. Try recovering factory set.
		Check whether the running command is sent.
	Check whether the operation frequency is set at 0.	
The motor can not Acc/Dec successfully		Improper setting of Acc/Dec time. Increase the value of Acc/Dec time.
		The current limit is set too low. Increase the value.
		Over-voltage protection action during decelerating. Increase the decelerating time.
		Improper setting of carrier frequency, too much load may cause oscillation.
		The load is too heavy, and the torque is not enough. Increase torque boost value in V/F mode. If not working, switch to auto torque boost mode, and the motor parameters should be in consistent with the actual value. If still not working, switch to flux vector control mode, and check the motor parameters and actual values to see if they are matched, meanwhile tune the motor parameters.
	Mismatching of motor power and driver power. Set the motor parameters at actual value.	

	One driver for several motor. Please change the torque boost mode to manual mode.
The motor can rotate, but speed regulation can't be realized.	Improper setting of upper and lower limit of frequency
	The frequency is set too low, or the frequency gain is set too low.
	Check whether the speed adjustment mode is in consistent with frequency setting.
	Check whether the load is too heavy, whether it is in overvoltage stalled state or overcurrent limiting state.
Speed changing during running	Frequent fluctuation of load. Decrease the changing.
	Serious mismatching of rated value of the driver and motor. Set the motor
	Frequency setting potentiometer is in bad connect or the frequency setting signal is in fluctuation. Switch to digit setting mode or increase filter time constant of analog input signal.
The rotation direction of motor is in reverse	Adjust phase sequence of output terminal U, V, W
	Set the running direction as reverse (F0.21=1)
	Caused by phase loss of output. Check the motor wiring immediately.

Appendix: A. Communication Protocol

1.RTU mode and format

When controller communicates via Modbus in RTU mode, each byte is divided into 2 hexadecimal characters of 4 bits. The main advantage of this mode is that it can transfer characters with higher density compared with ASCII mode given the condition of the same baud rate, and each information must be transported continuously.

1) Each byte format in RTU mode

Encoding system: 8 bits binary, hexadecimal 0-9, A-F.

Data bits: 1 bit of start bit, 8 bits of data (send from the lower bit), 1 bit of stop bit, optional parity check bit (refer to bit sequence of RTU data frame).

Error check zone: cyclic redundancy check (CRC).

2) Bit sequence of RTU data frame

With parity check

Start	1	2	3	4	5	6	7	8	Par	Stop
-------	---	---	---	---	---	---	---	---	-----	------

Without parity check

Start	1	2	3	4	5	6	7	8	Stop
-------	---	---	---	---	---	---	---	---	------

2.Register Address and Function Code

1) supported function code

Function code	Function description
03	Read multiple registers
06	Write single register
10	Write multiple registers continuously
13	Read single parameter

2) register address

Register function	Address
Control command input	0x2000
Read monitor parameter	0xD000 (0x1D00) ~0xD039 (0x1D39)
MODBUS frequency setting	0x2001
MODBUS torque setting	0x2002
MODBUS PID frequency	0x2003
MODBUS PID feedback	0x2004
Parameter setting	0x0000~0x0F15

3) 03H read multiple parameters (8 items continuously at most)

Inquiry information frame format (send frame) :

Address	01H
Function	03H
Starting data address	00H
	01H
Number of Data(Byte)	00H
	02H
CRC CHK High	95H
CRC CHK Low	CBH

Analysis of this segment data:

01H is the address of the driver 03H read function code

0001H is start address, equivalent to F0.01 of control panel

0002H is item count of menu, i.e. the two items of F0.01 and F0.02

95CBH is 16 bits of CRC check code

Response information frame format (return frame) :

Address	01H
Function	03H
DataNum*2	04H
Data1[2Byte]	00H
	64H
Data2[2Byte]	00H
	64H
CRC CHK High	BAH
CRC CHK Low	07H

Analysis of this segment data:

- 01H is the address of the driver
- 03H read function code
- 04H is the product of (read item)*2
- 0064H read the data of F0.01
- 0064H read the data of F0.02
- BA07H is 16 bits of CRC check code

Example:

name	Frame format
Read data of F0.01 and F0.02	Send frame: 01H 03H 0001H 0002H 95CBH
	Return frame: 01H 03H 04H 0064H 0064H
Read data of F2.01	Send frame: 01H 03H 0201H 0001H D472H
	Return frame: 01H 03H 02H 000FH F840H
Read monitor parameter of d-00 (a address D000H and 1D00H interchangeable)	Send frame: 01H 03H D000H 0001H BCCA H
	Return frame: 01H 03H 02H 1388H B512H
	Send frame: 01H 03H 1D00H 0001H 8266H
	Return frame: 01H 03H 02H 1388H B512H
Read the status when the driver stops (address A000H and 1A00H interchangeable, refer to the run status description of the driver)	Send frame: 01H 03H A000H 0001H A60AH
	Return frame: 01H 03H 02H 0040H B9B4H
	Send frame: 01H 03H 1A00H 0001H 8312H
	Return frame: 01H 03H 02H 0040H B9B4H
Read fault code E-19 (address E000H and 1E00H interchangeable, refer to the fault code table)	Send frame: 01H 03H E000H 0001H B3CAH
	Return frame: 01H 03H 02H 0013H F989H
	Send frame: 01H 03H 1E00H 0001H 8222H
	Return frame: 01H 03H 02H 0013H F989H
Read pre-alarm code A-18 (address E001H and 1E01 interchangeable, refer to the pre-alarm code table)	Send frame: 01H 03H E001H 0001H E20AH
	Return frame: 01H 03H 02H 0012H 3849H
	Send frame: 01H 03H 1E01H 0001H D3E2H
	Return frame: 01H 03H 02H 0012H 3849H

4) 06H write single parameter

Inquiry information frame format (send frame) :

Address	01H
Function	06H
Starting data address	20H
	00H
Data(2Byte)	00H
	01H
CRC CHK Low	43H
CRC CHK High	CAH

Analysis of this segment data:

01H is the address of the driver
 06H write function code
 2000H is the address of control command
 0001H is forward command
 43A1H is 16 bits of CRC check code

Response information frame format (return frame) :

Address	01H
Function	06H
Starting data address	20H
	00H
Number of Data(Byte)	00H
	01H
CRC CHK High	43H
CRC CHK Low	CAH

Analysis of this segment data: if set right, return the same input data

Example:

	Frame format
Forward	Send frame 01H 06H 2000H 0001H 43CAH
	Return frame: 01H 06H 2000H 0001H 43CAH
Reverse	Send frame 01H 06H 2000H 0009H 420CH
	Return frame: 01H 06H 2000H 0009H 420CH
Stop	Send frame 01H 06H 2000H 0003H C20BH
	Return frame: 01H 06H 2000H 0003H C20BH
Free stop	Send frame 01H 06H 2000H 0004H 83C9H
	Return frame: 01H 06H 2000H 0004H 83C9H
Reset	Send frame 01H 06H 2000H 0010H 43CAH
	Return frame: 01H 06H 2000H 0010H 43CAH
Forward jog	Send frame: 01H 06H 2000H 0002H 03CBH
	Return frame: 01H 06H 2000H 0002H 03CBH
Reverse jog	Send frame: 01H 06H 2000H 000AH 020DH
	Return frame: 01H 06H 2000H 000AH 020DH
Set F8.00 parameter at 1	Send frame: 01H 06H 0800H 0001H 4A6AH
	Return frame: 01H 06H 0800H 0001H 4A6AH
MODBUS reference frequency 40HZ	Send frame: 01H 06H 2001H 0FA0H D642H
	Return frame: 01H 06H 2001H 0FA0H D642H
MODBUS PID reference 5V	Send frame: 01H 06H 2003H 01F4H 721DH
	Return frame: 01H 06H 2003H 01F4H 721DH
MODBUS PID feedback 4V	Send frame: 01H 06H 2004H 0190H C237H
	Return frame: 01H 06H 2004H 0190H C237H
MODBUS torque set at 80%	Send frame: 01H 06H 2002H 0320H 22E2H
	Return frame: 01H 06H 2002H 0320H 22E2H
User password check (address AD00H and 1C00H interchangeable)	Send frame: 01H 06H AD00H 0001H 68A6H
	Return frame: 01H 06H AD00H 0001H 68A6H
	Send frame: 06H 1C00H 0001H 4F9AH
	Return frame: 01H 06H 1C00H 0001H 4F9AH
Check operation limit password (address AD01H and 1C01H interchangeable)	Send frame: 01H 06H AD01H 0002H 7967H
	Return frame: 01H 06H AD01H 0002H 7967H
	Send frame: 01H 06H 1C01H 0002H 5E5BH
	Return frame: 01H 06H 1C01H 0002H 5E5BH

5) 10H write multiple parameters continuously

Inquiry information frame format (send frame) :

Address	01H
Function	10H
Starting data address	01H
	00H
Number of Data(Byte)	00H
	02H
DataNum*2	04H
	00H
Data1(2Byte)	01H
	00H
Data2(2Byte)	02H
	00H
CRC CHK High	2EH
CRC CHK Low	3EH

Analysis of this segment data:

- 01H is the address of the driver
- 10H write function code
- 0100H start address, equivalent to F1.00 of control panel
- 0002H amount of registers
- 04H bytes sum (2*register amount)
- 0001H data of F1.00 0002H data of F1.01
- 2E3EH 16 bits of CRC check code

Response information frame format (return frame) :

Address	01H
Function	10H
Starting data address	01H
	00H
Number of Data(Byte)	00H
	02H
CRC CHK High	40H
CRC CHK Low	34H

Analysis of this segment data:

- 01H address of the driver
- 10H write function code
- 0100H write data of F1.00
- 0002H item count of write menu, i.e. two items of F1.00 and F1.01
- 4034H 16 bits of CRC check code

Example:

Name	Frame format
Set F1.00, F1.01 at 1 and 0.02 respectively	Send frame: 01H 10H 0100H 0002H 04H 0001H 0002H 2E3EH
	Return frame: 01H 10H 0100H 0002H 4034H
Forward and communicate reference frequency at 50HZ	Send frame: 01H 10H 2000H 0002H 04H 0001H 1388H 36F8H
	Return frame: 01H 10H 2000H 0002H 4A08H
Set F1.00 at 1	Send frame: 01H 10H 0100H 0001H 02H 0001H 7750H
	Return frame: 01H 10H 0100H 0001H 0035H

6) 13H read single parameter (including attribute, min.value, max.value)

Inquiry information frame format (send frame) :

Address	01H
Function	13H
Starting data address	00H
	0CH
Number of Data(Byte)	00H
	04H
CRC CHK High	45H
CRC CHK Low	CBH

Analysis of this segment data:

- 01H address of the driver
- 13H read function code
- 000CH start address, equivalent to F0.12 of control panel
- 0004H register amount
- 45CBH 16 bits of CRC check code

Inquiry information frame format (return frame) :

Address	01H
Function	13H
Starting data address	00H
	12H
Data1(2Byte)	13H
	88H
Data2(2Byte)	03H
	22H
Data3(2Byte)	00H
	00H
Data4(2Byte)	13H
	88H
CRC CHK High	28H
CRC CHK Low	31H

Analysis of this segment data:

- 01H address of the driver
- 13H write function code
- 000CH start address, equivalent to F0.12 of control panel
- 1388H parameter value
- 0322H attribute value
- 0000H min.value
- 1388H max.value
- 2831H 16 bits of CRC check code

Example:

Name	Frame format
Read parameter value of F0.12	Send frame: 01H 13H 000CH 0001H 85CAH
	Return frame: 01H 13H 02H 1388H B1D2H
Read parameter value + attribute value of F0.12	Send frame: 01H 13H 000CH 0002H C5CBH
	Return frame: 01H 13H 04H 1388H 0322H FCE4H
Read parameter value + attribute value + min.value of F0.12	Send frame: 01H 13H 000CH 0003H 040BH
	Return frame: 01H 13H 06H 1388H 0322H 0000H 628BH
Read parameter value + min.value + max.value of F0.12	Send frame: 01H 13H 000CH 0004H 45CBH
	Return frame: 01H 13H 08H 1388H 0322H 0000H

3 .Functions of other Register Address:

function	address	description		
		byte	bit	meaning
VFD operation status	A000H(1A00H)	Byte1	Bit7	0: no action 1: overload pre-alarm
			Bit6~Bit5	0:INV_220V 1:INV_380V 2:INV_660V 3:INV_1140V
			Bit4	0: no action 1: power off save
			Bit3	0: no action 1: reset
			Bit2~Bit1	0: no action 1: static tuning 2: dynamic tuning
			Bit0	0: control panel mode 1: terminal control mode 2: communication control mode 3: reserved
		Byte0	Bit7	
VFD operation status	A000H(1A00H)	Byte0	Bit6	0: no action 1: bus voltage is normal
			Bit5	0: no action 1: undervoltage
			Bit4	0: no action 1: jog run
			Bit3	0: forward 1: reverse
			Bit2~Bit1	1: Acc 2: Dec 3: constant speed
			Bit0	0: stop status 1: run status
Read VFD fault code	E000H(1E00H)	Address E000H and 1E00H interchangeable (refer to fault code table and example of read function code 03H)		
Read VFD fault pre-alarm	E001H(1E01H)	Address E001H and 1E01H interchangeable (refer to example of pre-alarm code, read function code 03H)		
User password check	AD00H(1C00H)	Address AD00H and 1C00H interchangeable (refer to example of write function code 06H)		
Operation limit password	AD01H(1C01H)	Address AD00H and 1C00H interchangeable (refer to example of write function code 06H)		

4 Fault Code:

Fault code	Displayed code	Fault information
0000H	—	No fault
0001H	E-01	Overcurrent when accelerating
0002H	E-02	Overcurrent when decelerating
0003H	E-03	Overcurrent at constant speed
0004H	E-04	Overvoltage when accelerating
0005H	E-05	Overvoltage when decelerating
0006H	E-06	Overvoltage at constant speed
0007H	E-07	Bus undervoltage
0008H	E-08	Motor overload
0009H	E-09	Driver overload
000AH	E-10	Driver off load
000BH	E-11	Function module fault
000CH	E-12	Input phase loss
000DH	E-13	Output phase loss or current unbalance
000EH	E-14	Short circuit of output to earth
000FH	E-15	Heatsink overheat 1
0010H	E-16	Heatsink overheat 2
0011H	E-17	RS485 communication fault
0012H	E-18	Keypad communication fault
0013H	E-19	External device fault
0014H	E-20	Current detection fault
0015H	E-21	Motor tuning fault
0016H	E-22	EEPROM read-write fault
0017H	E-23	Parameters copy fault
0018H	E-24	PID feedback disconnection
0019H	E-25	Voltage feedback disconnection
001AH	E-26	Arrival of operation limit time
001BH	E-27	Coprocessor communication fault
001CH	E-28	Encoder disconnection fault
001DH	E-29	Speed deviation too much
001EH	E-30	Over-speed fault

5.Pre-alarm Code of the Driver:

Alarm code	displayed	Fault information
0000H	—	No fault
0009H	A-09	Driver overload alarm
0011H	A-17	RS485 communication fault alarm
0012H	A-18	Keypad communication fault alarm
0015H	A-21	Motor tuning alarm
0016H	A-22	EEPROM read-write fault alarm
0018H	A-24	PID feedback disconnection alarm

6. Control Command Format (see function code 06H example):

address	bit	meaning
2000H	Bit7~Bit5	reserved
	Bit4	0: no action 1: reset

	Bit3	0: forward 1: reverse
	Bit2~Bit0	100: free stop 011: stop 010 : jog run 001 : run

7. Parameter Attribute:

bit	meaning
Bit15	reserved
Bit14	menu
Bit13	system
Bit12	reset to factory defaults
Bit11	EEPROM
	"○":01
	"×":10
	"◇":00
Bit8	sign
	1:00000
	V:00001
	A:00010
	rpm:00011
	HZ:00100
	%:00110
	S:01000
Bit2~Bit0	

8. Error Code from Slave Response of Abnormal Information:

Error code	description
01H	Invalid function code
02H	Invalid address
03H	Invalid data
04H	Invalid register length
05H	CRC validation error
06H	Parameters can't be changed during running
07H	The changes of parameters are invalid
08H	Control command of host is invalid
09H	Parameter protected by password

9. Communication Address of all Parameters:

Function code	Communication address
F0.00~F0.22	0000H~0016H
F1.00~F1.36	0100H~0124H
F2.00~F2.17	0200H~0211H
F3.00~F3.08	0300H~0308H
F4.00~F4.24	0400H~0418H
F5.00~F5.24	0500H~0518H
F6.00~F6.35	0600H~0623H
F7.00~F7.36	0700H~0724H
F8.00~F8.20	0800H~0814H
F9.00~F9.73	0900H~0949H
FA.00~FA.35	0A00H~0A23H
FB.00~FB.06	0B00H~0B06H

FC.00~FC.25	0C00H~0C19H
FE.00~FE.15	0E00H~0E0FH
FF.00~FF.21	0F00H~0F15H
d-00~d-57	D000H (1D00H) ~D039H (1D39H)

Notice:

- 1) in the above examples, the driver address is 01, which makes it better for illustration; when the driver is slave, the address setting range is 1~247, and if any data of frame format is changed, the check code needs to be recalculated. The calculating tools of 16bit CRC check code can be download from internet.
- 2) Initial address of monitor item is D000, each item offset corresponding hexadecimal value based on this address, then plus it with the initial address. For example: the monitor initial item is d—00, the corresponding initial address is D000H (1D00H), now read monitor item d—18, 18-00=18, the corresponding hexadecimal of 18 is 12H, then the read address of d—18 is D000H+12H = D012H (1D00H+12H = 1D12H). Address D000H and 1D00H are interchangeable.
- 3) Frame format when the slave response information is abnormal: driver address + (80H+function code) + 16bit CRC check code; if the salve return frame is 01H + 83H + 04H + 40F3H, then 01H is slave address, 83H is 80H+03H indicating read error, 04H is invalid data length, 40F3H is 16bit CRC check code.

B.Warranty agreement

1 this product warranty period is twelve months (based on the fuselage bar type code information), during the warranty period, according to the normal use of the instructions, the product failure or damage, our company is responsible for free repair.

2 within the warranty period, due to the following causes of damage, will receive a certain maintenance costs:

A, machine damage due to errors in use and self repair and reconstruction without authorization;

B damage caused by fire, flood, voltage anomaly, other natural disasters and two disasters;

C, hardware damage caused by artificial falling and transportation after purchase;

D, damage to the machine caused by the operation of the user's manual supplied by our company;

E and malfunction and damage caused by obstacles outside the machine (such as external equipment factors);

3, when the product failure or damage, please correct and detailed fill in "product warranty card" in the content.

4 the maintenance fee shall be charged according to the latest maintenance price list of our company.

5 the warranty cards in general will not be reissued, honesty please keep this card and show it to the maintenance personnel in maintenance.

6 if there is any problem in the service process, please contact our agent or our company in time.